

SIEMENS



SIRIUS Modular System

Highly flexible system-based switching, protecting and starting

[siemens.com/sirius](https://www.siemens.com/sirius)

Answers for industry.

Everything for the electrical cabinet: SIRIUS Modular System.

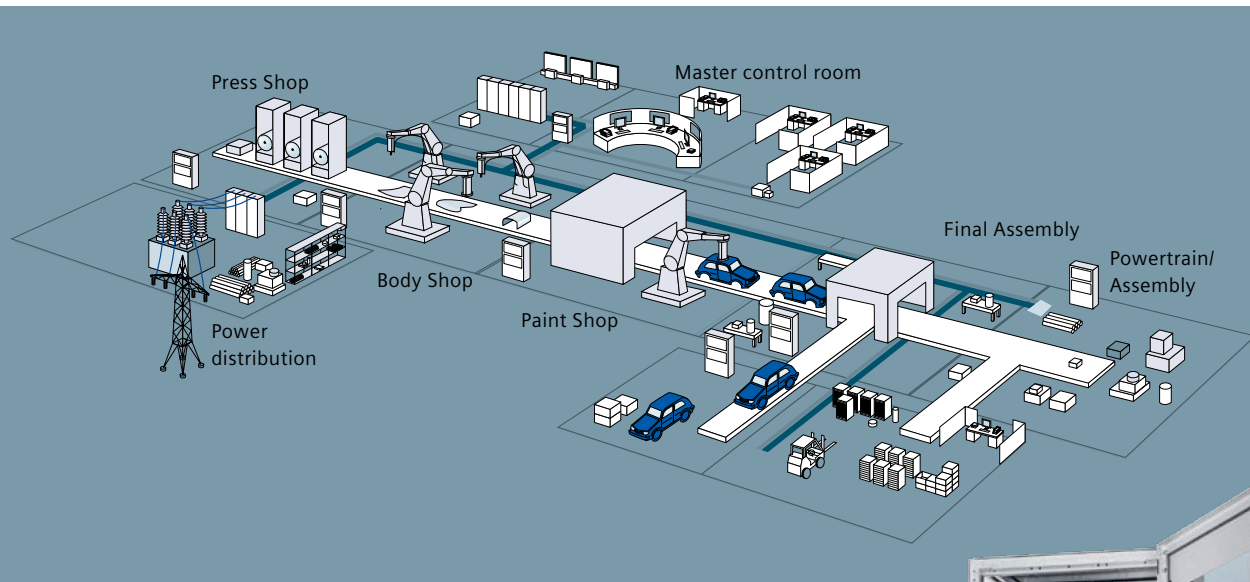

Pressing, equipping, transporting.
These functions run in many automated
production environments. You'll find
everything that you need to switch, protect
and start motors with the extensive portfolio
of the modular SIRIUS system.
Everything. Easy. SIRIUS



Contents

SIRIUS Modular System Components	4
Switching and Protection Device Combinations	8
Comfortable Power Infeed and Distribution	9
Electromechanical Switching Devices for the Fuseless Assembly of Load Feeders up to 7.5 kW	
Size S00 Selection and Ordering Data:	
Circuit Breaker, Contactor with Overload Relay	10
Circuit Breaker, Contactor with Current Monitoring Relay	10
Circuit Breaker, Soft Starter with Current Monitoring Relay	13
Circuit Breaker, Solid-State Switching Device with Current Monitoring Relay	13
Electromechanical Switching Devices for the Fuseless Assembly of Load Feeders up to 18.5 kW	16
Size S0 Selection and Ordering Data:	
Circuit Breaker, Contactor, Overload Relay	17
Circuit Breaker, Contactor with Current Monitoring Relay	17
Circuit Breaker, Soft Starter with Current Monitoring Relay	18
Assembly of Direct-On-Line and Reversing Starters up to 22 kW	20
Size S2 Selection and Ordering Data	
Assembly of Direct-On-Line and Reversing Starters up to 45 kW	22
Size S3 Selection and Ordering Data	
Size S6, S10 and S12 Selection and Ordering Data	24
Fuseless Load Feeders Selection and Ordering Data:	
Direct-On-Line Starters (Completely Pre-Assembled Load Feeders, Compact Starters)	26
Reversing Starters (Completely Pre-Assembled Load Feeders, Compact Starters)	27
Communication Connection	
(IO-Link / AS-Interface masters, contactors, function modules for Mounting on 3RT2 Contactors and for Connection to the Control, Compact Starters)	28
Infeed Systems	
For Compact Starters, Load Feeders, 3-Phase Busbars, 8US Busbar Adapters	31
Accessories Selection and Ordering Data:	
Circuit Breakers	34
Contactors	36
Overload Relays, Current Monitoring Relays	40
Service & Support	42

Everything. System-based. SIRIUS Modular System.

How to realize fast, easy, flexible and space-saving control cabinet assembly? With the unique SIRIUS modular system, which offers everything required for the switching, protection and starting of motors and systems. It comprises a modular range of standard components up to 250 kW / 400 V in only seven optimally matched sizes which can be easily combined and utilize largely identical accessories. Switching technology made easy!

The permanent advancement and continuous innovation of SIRIUS optimally prepare our customers for current and future requirements and provide them with efficient solutions. All components of the SIRIUS modular system are characterized by their space-saving design and high degree of flexibility. Configuration, installation, wiring and maintenance can be realized easily and in minimum time. No matter whether you want to assemble load feeders with circuit breakers or overload relays, contactors / solid-state contactors, reversing contactors or soft starters – SIRIUS offers the suitable product for every application.

Thanks to the latest innovations of sizes S00 and S0 up to 40 A, the new SIRIUS modular system now offers even more functional diversity:

In addition to the innovated basic components (such as contactors, circuit breakers and overload relays), the innovated SIRIUS modular system offers unprecedented highlights:

- Feeder combinations which can be completely plug-connected without tools thanks to consistently implemented spring-loaded connection system
- 2- and 3-phase 3RR2 current monitoring relays for direct mounting on contactors
- 3RA27 and 3RA28 function modules which can be plugged onto contactors for the easy assembly of direct-on-line, reversing and star-delta starters and for connection to the control via AS-Interface or IO-Link with minimized wiring

Circuit breakers



Contactors



Overload relays



Soft starters



Overview of the Numerous Advantages Offered by the SIRIUS Modular System.

With its manifold components, the SIRIUS modular system covers various functions for control cabinet applications and offers numerous advantages in terms of assembly and handling, application monitoring, connection to the control as well as planning and configuration.

Assembly and handling:

Reduced wiring expenditures and fault avoidance – with maximum flexibility

- **Load feeders:** Easy realization with standard devices up to 250 kW / 400 V
- **Modular system:** All components are matched and can be combined
- **Versions and sizes:** Efficiency and flexibility with 7 compact sizes
- **Accessories:** Minimum variance with integrated accessories
- **Assembly:** Fast commissioning, short setup times, easy wiring
- **Mounting:** Permanently safe mounting with screw-type or easy plug-in connection system
- **Spring-loaded connection system:** Fast and safe connection, vibration-proof and with zero maintenance
- **Reduced wiring:** Considerably reduced number of line connections thanks to plug-in connection system and IO-Link or AS-Interface

Application control:

Improved operational reliability and system availability

- **Maintenance:** Extremely long service life, low maintenance and reliability
- **Application monitoring:** Flexibly integrated in the feeder thanks to current monitoring relay

Connection to the control:

Optimum integration in the automation environment

- **Communication:** Standardized connection to AS-Interface, IO-Link and PROFIBUS DP possible

Planning and configuration:

Eased system planning and documentation

- **Configuration:** Easy and fast thanks to comprehensive CAX data provision
- **Service:** Short delivery periods also for spare parts thanks to worldwide logistics network
- **Environment:** Environmentally compatible production and materials, recyclability
- **Design:** Clear and ergonomic, awarded with the iF Product Design Award
- **Configurator:** For easy product selection, incl. accessories
- **Global applicability:** Thanks to comprehensive approvals



Switching. Protecting. Starting.

The components of the SIRIUS Modular System.



Far more than ON/OFF: SIRIUS 3RV circuit breakers

SIRIUS 3RV circuit breakers (MSP) are compact, current-limiting circuit breakers. They guarantee safe reliable shutdown when short circuits occur and protect loads and plants against overload. Furthermore, they are suitable for operationally switching load feeders with a low operating frequency and safely disconnecting the plant or system from the line supply when service is being carried out or changes are being made. SENTRON 3VL circuit breakers are suitable for applications above 100 A. As infeed and load feeder breaker, they protect plants and motors against short circuit and overload.



Rugged and reliable: SIRIUS 3RT contactors

Due to their extremely high ruggedness and optimum contact reliability, our contactors switch with supreme confidence. Furthermore, compact electrical cabinets can be configured with high packing densities. The reason for this is that the auxiliary switch blocks and solenoid protective circuitry are located within the envelope contours of the contactors. This makes it easier to expand the system and saves considerable space in the electrical cabinet. With size S00 and S0 contactors, the auxiliary switches are already integrated in the enclosure.



Tripping when things get tough: SIRIUS 3RU and 3RB overload relays

The overload relays of the SIRIUS family, available as either thermal or solid-state versions, protect loads connected to the main circuit, as a function of the current, and also protect other switching and protective devices in the particular load feeder. The solid-state SIRIUS 3RB2 overload relays guarantee seamless motor and plant protection from 0.1 A to 630 A. Due to the wide setting ranges, the current range is covered with a minimum number of versions.



Easy application monitoring: SIRIUS 3RR2 current monitoring relays

The SIRIUS current monitoring relays not only monitor the motor, but the entire system or driven process for overcurrent and undercurrent, cable breakage and phase failure. For example, load shedding or overload of an application is promptly detected and signaled at an early stage. Sizes S00 and S0 of the 3RR2 current monitoring relay are directly integrated in the load feeder. They simply have to be plugged onto the contactor: Click 'n' go.



Gentle starting: SIRIUS 3RW soft starters

SIRIUS 3RW soft starters offer a seamless range that covers all standard and high-feature motor starting applications. They can be used in the widest range of applications to exploit the advantages of soft starting for the easy and efficient realization of optimum machine concepts. The compact two-phase-controlled 3RW30 facilitates efficient and space-saving soft starting up to 55 kW (with 400 V). The 3RW40 additionally offers soft stopping as well as integrated intrinsic device and motor protection functions, thanks to which an additional overload relay is unnecessary. Device versions up to a rating of 55 kW (with 400 V) are available: Thermistor motor protection evaluation, 400–600 V.

Switching. Protecting. Starting.

The components of the SIRIUS Modular System.



Competent control of high switching frequencies: SIRIUS 3RF solid-state contactors

SIRIUS solid-state contactors (size S0) for motor switching offer an almost unlimited service life – even under harsh conditions and with high switching frequencies. The three-phase solid-state contactors switch motors up to 7.5 kW in an absolutely noise-free manner. A special reversing contactor version facilitates direction of rotation changes of motors up to 3 kW. The compact devices in 45 or 90 mm width can be combined with our circuit breakers, current monitoring relays or solid-state overload relays. This supports the fast and easy assembly of fuseless and fused motor feeders.

Compact switching and protection with comprehensive additional functions: 3RA6 compact starters

Equipped with the functions of a circuit breaker, a contactor and a solid-state overload relay, the compact starter offers maximum reliability and minimum variance as direct-on-line or reversing starter up to 32 A. Safe disconnection upon the starter's end of service life offers an additional advantage in terms of system availability. Reduced wiring in the main circuit thanks to the brilliantly simple infeed system, incl. PE connection, and in the control circuit thanks to optional AS-Interface connection or integrated IO-Link interface supports the rapid assembly of complete feeder groups. The devices' incorporation in the Totally Integrated Automation concept and pre-defined icon blocks for visualization facilitate the output of significant device diagnostics without the normally required configuration expenditures.



SIRIUS contactor
screw connection



SIRIUS contactor
spring-loaded connection



SIRIUS contactor
ring cable lug connection

Fast, reliable and user-friendly: spring-loaded technology

For the first time, the entire S00/S0 range is available with spring-loaded connection system both in the main and control circuit. This accelerates device connection and offers maximum operational reliability. The outstanding ease of wiring ensures rapid mounting. The gas-tight clamp connection's vibration resistance represents a further advantage. In addition, this connection system offers maximum contact reliability – even under the harshest of conditions. The frequently required re-tightening of connection terminals is thus done away with.

A special bonus: Also the connecting modules for direct-on-line, reversing and star-delta starters are available with spring-loaded connection system to support the mounting of complete feeders without tools.

Maximum connection flexibility

Of course, all components of the SIRIUS modular system are also available with the screw-type connection system – largely even with ring cable lug – for special requirements, e.g. mechanical engineering applications in the semiconductor industry.

Switching. Protecting. Starting.

The components of the SIRIUS Modular System.



Straight ahead:
The 3RA11 direct starter



Phases interchanged:
The 3RA12 reversing starter



Two stages – one start:
The 3RA14 star-delta
combination

Ready for immediate use: Pre-wired SIRIUS load feeders

Load feeders start loads using a combination of protective and switching functions. Generally, a multiple number of components is required to implement every type of starter. In order to reduce time and costs – and especially to minimize downtimes – we offer you a wide range of pre-wired starter solutions:

- Direct starters up to 22 kW – the optimum starter combination for all motors. For high switching frequencies with solid-state contactors up to 7.5 kW.
- Reversing starters up to 11 kW – the matching combination for reversing motors. Solid-state reversing contactors can be used for applications with high switching frequencies up to 3 kW.
- Wye-delta* combinations up to 75 kW – the solution for running-up motors in stages.
- Soft starters – when soft starting and stopping is required (soft ramp-down as of 3RW40).

An almost unlimited number of further tested combinations can be easily assembled from the individual components. The SIRIUS Configuration manual offers selection support: Available under order number 3ZX1012-ORA21-1AC0 or for download via www.siemens.com/industrial-controls/support

Electromechanical controls	Fuse with contactor and overload relay	Motor starter protector for motor protection and contactor	Motor starter protector for motor protection with overload relay function and contactor	Starter motor starter protector, contactor and overload relay	Compact Starter	Motor starter protector for motor protection, contactor and current monitoring relay	Motor starter protector for motor protection with overload relay function, contactor and current
For details, see:*	See p. 12, 17, 26		See p. 11, 17		See p. 26, 27, 30		See p. 12, 17
Short circuit							
Switching							
Overload / Monitoring							
Fuse-protected		Non-fused					
Electronic controls	Motor starter protector for motor protection, soft starter and current monitoring relay	Starter motor starter protector, soft starter and current monitoring relay	Fuse and soft starter	Fuse and solid-state switching device	Fuse, solid-state switching device and current monitoring relay	Motor starter protector for motor protection and solid-state switching device	Motor starter protector for motor protection, solid-state switching device and current monitoring device
For details, see:*	See p. 14, 19		See p. 19		See p. 15		See p. 15
Short circuit							
Switching							
Overload / Monitoring							
Non-fused			Fuse-protected			Non-fused	

* For further details and solutions not listed here, refer to the IC10 catalog

Comfortable Power Infeed and Distribution: SIRIUS 3RV29 and 3RA68 Infeed Systems.



Efficient and flexible power distribution

The components of the SIRIUS modular system offer maximum wiring flexibility. They can be connected easily via the corresponding SIRIUS 3RV29 infeed system or the 3RA68 infeed system in conjunction with the compact starter. Both systems are respectively available for devices with screw-type and spring-loaded connection system. For connection, individual circuit breakers, complete load feeders or compact starters are simply clicked into the respective infeed system. Doing away with laborious wiring and fault risks, a complete feeder group is thus supplied with power: Click 'n' go!

Alternatively, also conventional wiring is supported: Via parallel wiring, 3-phase busbar or the 8US busbar adapter with which the SIRIUS load feeders can be directly mounted on a 60 mm busbar system.

These manifold combination options facilitate the effortless realization of your individual control cabinet solution – perfectly matched to your application.

Design highlights

- Outstanding flexibility for assembly and expansions
- Reduced space requirements in the control cabinet thanks to very compact design
- Infeed optionally from the left or right with conductor cross sections of up to 70 mm²
- Optional wiring duct between the feeders
- Additional integration of further 1-, 2- or 3-pole components via terminal block
- Maximum current carrying capacity of 100 A
- Integration of load feeders with screw-type and spring-loaded connection system
- High vibration resistance, particularly with switching devices featuring the spring-loaded connection system
- Time savings in terms of mounting thanks to easy plug-in connection system
- Also PE connection option with the 3RA68 infeed

Starter combinations of motor starter protector and contactor with overload relay

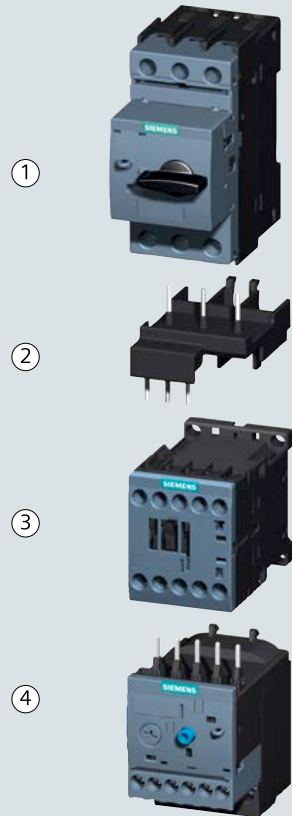

Type	Screw connection	Spring-loaded connection
① Motor starter protector*		
② Link module	3RA1921-1DA00	3RA2911-2AA00
③ Contactor (AC / DC)*		
④ Overload relay*		

* For order numbers of basic components see tabular overview on page 11

Starter combinations of motor starter protector and contactor with optional current monitoring relay

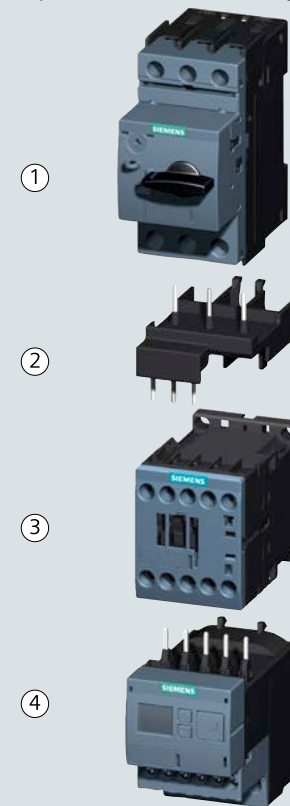

Type	Screw connection	Spring-loaded connection
① Motor starter protector*		
② Link module	3RA1921-1DA00	3RA2911-2AA00
③ Contactor (AC / DC)*		
④ Overload relay*		

* For order numbers of basic components see tabular overview on page 12

Starter combinations: motor starter protector, contactor with overload relay

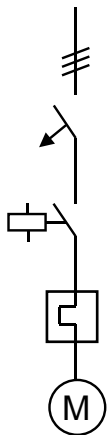

Three-phase motor 400 V/AC-3		Motor starter protector for starter protection	
[kW]	[A]	Setting range of thermal overload release CLASS 10 [A]	Order no.
0.04	0.16	-	3RV2311-0AC□0
0.06	0.2	-	3RV2311-0BC□0
0.06	0.25	-	3RV2311-0CC□0
0.09	0.32	-	3RV2311-0DC□0
0.09	0.4	-	3RV2311-0EC□0
0.12	0.5	-	3RV2311-0FC□0
0.18	0.63	-	3RV2311-0GC□0
0.18	0.8	-	3RV2311-0HC□0
0.25	1	-	3RV2311-0JC□0
0.37	1.25	-	3RV2311-0KC□0
0.55	1.6	-	3RV2311-1AC□0
0.75	2	-	3RV2311-1BC□0
0.75	2.5	-	3RV2311-1CC□0
1.1	3.2	-	3RV2311-1DC□0
1.5	4	-	3RV2311-1EC□0
1.5	5	-	3RV2311-1FC□0
2.2	6.3	-	3RV2311-1GC□0
3	8	-	3RV2311-1HC□0
4	10	-	3RV2311-1JC□0
5.5	12.5	-	3RV2311-1KC□0
7.5	16	-	3RV2311-4AC□0

Contactor		
Auxiliary contacts	Order no.	Order no.
	Control supply voltage	
	DC 24 V	AC 230 V, 50/60 Hz
1NC	3RT2015-□BB42	3RT2015-□AP02
1NO	3RT2015-□BB41	3RT2015-□AP01
1NC	3RT2016-□BB42	3RT2016-□AP02
1NO	3RT2016-□BB41	3RT2016-□AP01
1NC	3RT2017-□BB42	3RT2017-□AP02
1NO	3RT2017-□BB41	3RT2017-□AP01
1NC	3RT2018-□BB42	3RT2018-□AP02
1NO	3RT2018-□BB41	3RT2018-□AP01

Overload relay ¹⁾		
Setting range CLASS 10 [A]	Order no. Thermal	Order no. Electronic CLASS 10
0.11 – 0.16	3RU2116-0A□0	
0.14 – 0.2	3RU2116-0B□0	
0.18 – 0.25	3RU2116-0C□0	3RB3016-1R□0 (0.1 – 0.4 A)
0.22 – 0.32	3RU2116-0D□0	
0.28 – 0.4	3RU2116-0E□0	
0.35 – 0.5	3RU2116-0F□0	
0.45 – 0.63	3RU2116-0G□0	
0.55 – 0.8	3RU2116-0H□0	3RB3016-1N□0 (0.32 – 1.25 A)
0.7 – 1	3RU2116-0J□0	
0.9 – 1.25	3RU2116-0K□0	
1.1 – 1.6	3RU2116-1A□0	
1.4 – 2	3RU2116-1B□0	
1.8 – 2.5	3RU2116-1C□0	3RB3016-1P□0 (1 – 4 A)
2.2 – 3.2	3RU2116-1D□0	
2.8 – 4	3RU2116-1E□0	
3.5 – 5	3RU2116-1F□0	
4.5 – 6.3	3RU2116-1G□0	3RB3016-1S□0 (3 – 12 A)
5.5 – 8	3RU2116-1H□0	
7 – 10	3RU2116-1J□0	
9 – 12.5	3RU2116-1K□0	3RB3016-1T□0 (4 – 16 A)
11 – 16	3RU2116-4A□0	

¹⁾ Direct mounting on contactor, screw and spring-loaded connection possible

Screw connection: 1
Spring-loaded connection: 2

Screw connection: 1
Spring-loaded connection: 2

Ring cable lug connection: 4

Screw connection: B
Spring-loaded connection: C

Ring cable lug connection: J

Screw connection: B
Spring-loaded connection: E

Starter combinations:
motor starter protector,
contactor with optional current
monitoring relay

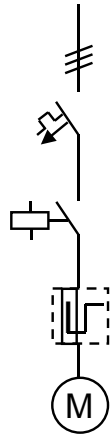

Three-phase motor 400 V/AC-3		Motor starter protector for motor protection	
[kW]	[A]	Setting range of thermal overload release CLASS 10 [A]	Order no.
0.04	0.16	0.11 – 0.16	3RV2011-0AA□0
0.06	0.2	0.14 – 0.2	3RV2011-0BA□0
0.06	0.25	0.18 – 0.25	3RV2011-0CA□0
0.09	0.32	0.22 – 0.32	3RV2011-0DA□0
0.09	0.4	0.28 – 0.4	3RV2011-0EA□0
0.12	0.5	0.35 – 0.5	3RV2011-0FA□0
0.18	0.63	0.45 – 0.63	3RV2011-0GA□0
0.18	0.8	0.55 – 0.8	3RV2011-0HA□0
0.25	1	0.7 – 1	3RV2011-0JA □0
0.37	1.25	0.9 – 1.25	3RV2011-0KA□0
0.55	1.6	1.1 – 1.6	3RV2011-1AA□0
0.75	2	1.4 – 2	3RV2011-1BA□0
0.75	2.5	1.8 – 2.5	3RV2011-1CA□0
1.1	3.2	2.2 – 3.2	3RV2011-1DA□0
1.5	4	2.8 – 4	3RV2011-1EA□0
1.5	5	3.5 – 5	3RV2011-1FA□0
2.2	6.3	4.5 – 6.3	3RV2011-1GA□0
3	8	5.5 – 8	3RV2011-1HA□0
4	10	7 – 10	3RV2011-1JA □0
5.5	12.5	9 – 12.5	3RV2011-1KA□0
7.5	16	11 – 16	3RV2011-4AA□0

Screw connection: 1
Spring-loaded
connection: 2
Ring cable lug
connection: 4

Contactor		
Auxiliary contacts	Order no.	Order no.
	Control supply voltage	
	DC 24 V	AC 230 V, 50/60 Hz
1NC	3RT2015-□BB42	3RT2015-□AP02
1NO	3RT2015-□BB41	3RT2015-□AP01
1NC	3RT2016-□BB42	3RT2016-□AP02
1NO	3RT2016-□BB41	3RT2016-□AP01
1NC	3RT2017-□BB42	3RT2017-□AP02
1NO	3RT2017-□BB41	3RT2017-□AP01
1NC	3RT2018-□BB42	3RT2018-□AP02
1NO	3RT2018-□BB41	3RT2018-□AP01

Screw connection: 1
Spring-loaded
connection: 2
Ring cable lug
connection: 4

Current monitoring relay		
Measure- ment range	Order no. Basic (analog setting)	Order no. Standard (digital setting)
[A]		
1.6 – 16	3RR2141-□A□30	3RR2241-□F□30

Screw connection: 1
Spring-loaded
connection: 2
AC/DC 24 V: A
AC/DC 24–240 V: W

Design up to 7.5 kW (S00)

Starter combinations:
motor starter protector, soft starter with optional
current monitoring relay (for stand-alone mounting)

	Type	Screw connection	Spring-loaded connection
①	Motor starter protector *		
②	Link module	3RA2921-1BA00	3RA2911-2GA00
③	Soft starter *		
④	Adapter for stand-alone assembly	3RU2916-3AA01	3RU2916-3AC01
⑤	Current monitoring relay * ¹⁾		
	* For order numbers of basic components see tabular overview on page 14		

① 

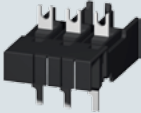
② 

③ 

④ 

⑤ 

1) An adapter for stand-alone assembly is required for the application of a 3RR2 current monitoring relay on a 3RW30/40 soft starter. The current monitoring relay must not be active during the start-up and ramp-down phase (phase control).
For 3RW30: The 3RR2 monitoring relay is to be enabled via an upstream timing relay after soft start-up completion.
For 3RW40: The 3RR2 monitoring relay is to be enabled/disabled via the BYPASS output (start-up detection).

Non-fused, electronic switching design

Starter combinations:
motor starter protector, solid-state switching
device with optional current monitoring relay

	Type	Screw connection
①	Motor starter protector *	
②	Link module	3RA2921-1BA00
③	Solid-state contactor / solid-state reversing contactor *	
④	Adapter for stand-alone assembly	3RU2916-3AA01
⑤	Current monitoring relay * ¹⁾	
	* For order numbers of basic components see tabular overview on page 15	

① 

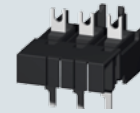
② 

③ 

④ 

⑤ 

1) An adapter for stand-alone assembly is required for the application of a 3RR2*41 current monitoring relay of size S00.

Starter combinations: motor starter protector, soft starter with optional current monitoring relay (for stand-alone mounting)

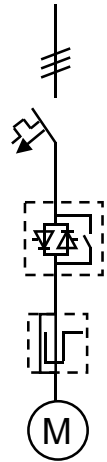

Three-phase motor 400 V/AC-3		Motor starter protector		Soft starter ¹⁾			Current monitoring relay		
[kW]	[A]	Setting range of thermal overload release CLASS 10	Order no.	Rated operating current	Order no.	Order no.	Measurement range	Order no. Basic (analog setting)	Order no. Standard (digital setting)
		[A]		[A]	Control supply voltage	Control supply voltage	[A]		
0.04	0.16	0.11 – 0.16	3RV2011-0AA□0						
0.06	0.2	0.14 – 0.2	3RV2011-0BA□0						
0.06	0.25	0.18 – 0.25	3RV2011-0CA□0						
0.09	0.32	0.22 – 0.32	3RV2011-0DA□0						
0.09	0.4	0.28 – 0.4	3RV2011-0EA□0						
0.12	0.5	0.35 – 0.5	3RV2011-0FA□0						
0.18	0.63	0.45 – 0.63	3RV2011-0GA□0						
0.18	0.8	0.55 – 0.8	3RV2011-0HA□0	3.6	3RW3013-□BB04	3RW3013-□BB14			
0.25	1	0.7 – 1	3RV2011-0JA□0						
0.37	1.25	0.9 – 1.25	3RV2011-0KA□0						
0.55	1.6	1.1 – 1.6	3RV2011-1AA□0						
0.75	2	1.4 – 2	3RV2011-1BA□0						
0.75	2.5	1.8 – 2.5	3RV2011-1CA□0						
1.1	3.2	2.2 – 3.2	3RV2011-1DA□0						
1.5	4	2.8 – 4	3RV2011-1EA□0						
1.5	5	3.5 – 5	3RV2011-1FA□0	6.5	3RW3014-□BB04	3RW3014-□BB14			
2.2	6.3	4.5 – 6.3	3RV2011-1GA□0						
3	8	5.5 – 8	3RV2011-1HA□0	9	3RW3016-□BB04	3RW3016-□BB14	1.6 – 16	3RR2141-□A□30	3RR2241-□F□30
4	10	7 – 10	3RV2011-1JA□0						
5.5	12.5	9 – 12.5	3RV2011-1KA□0	12.5	3RW3017-□BB04	3RW3017-□BB14			
7.5	16	11 – 16	3RV2011-4AA□0	17.6	3RW3018-□BB04	3RW3018-□BB14			

Screw connection: 1
Spring-loaded connection: 2
Ring cable lug connection: 4

Screw connection: 1
Spring-loaded connection: 2

Screw connection: 1
Spring-loaded connection: 2
AC/DC 24 V: A
AC/DC 24–240 V: W

¹⁾ Rated operating voltage 200 ... 480 V

Starter combinations: motor starter protector, soft starter with optional current monitoring relay (for stand-alone mounting)



Three-phase motor 400 V/AC-3		Motor starter protector	
[kW]	[A]	Setting range of thermal overload release CLASS 10 [A]	Order no.
0.04	0.16	0.11 – 0.16	3RV2011-0AA□0
0.06	0.2	0.14 – 0.2	3RV2011-0BA□0
0.06	0.25	0.18 – 0.25	3RV2011-0CA□0
0.09	0.32	0.22 – 0.32	3RV2011-0DA□0
0.09	0.4	0.28 – 0.4	3RV2011-0EA□0
0.12	0.5	0.35 – 0.5	3RV2011-0FA□0
0.18	0.63	0.45 – 0.63	3RV2011-0GA□0
0.18	0.8	0.55 – 0.8	3RV2011-0HA□0
0.25	1	0.7 – 1	3RV2011-0JA□0
0.37	1.25	0.9 – 1.25	3RV2011-0KA□0
0.55	1.6	1.1 – 1.6	3RV2011-1AA□0
0.75	2	1.4 – 2	3RV2011-1BA□0
0.75	2.5	1.8 – 2.5	3RV2011-1CA□0
1.1	3.2	2.2 – 3.2	3RV2011-1DA□0
1.5	4	2.8 – 4	3RV2011-1EA□0
1.5	5	3.5 – 5	3RV2011-1FA□0
2.2	6.3	4.5 – 6.3	3RV2011-1GA□0
3	8	5.5 – 8	3RV2011-1HA□0
4	10	7 – 10	3RV2011-1JA□0
5.5	12.5	9 – 12.5	3RV2011-1KA□0
7.5	16	11 – 16	3RV2011-4AA□0

Solid-state contactor ²⁾		
Rated operating current	Order no.	Order no.
	Control supply voltage	
[A]	DC 24 V	AC 110 – 230 V, 50/60 Hz
5.2	3RF3405-□BB04	3RF3405-□BB24
9.2	3RF3410-□BB04 ¹⁾	3RF3410-□BB24 ¹⁾
12.5	3RF3412-□BB04 ¹⁾	3RF3412-□BB24 ¹⁾
16	3RF3416-□BB04 ¹⁾	3RF3416-□BB24 ¹⁾

Current monitoring relay		
Measurement range	Order no. Basic (analog setting)	Order no. Standard (digital setting)
[A]		
1.6 – 16	3RR2141-□A□30	3RR2241-□F□30
4 – 16	3RR2142-□A□30 ³⁾	3RR2242-□F□30 ³⁾

¹⁾ Overall width 90 mm
²⁾ Rated operating voltage U_e 48 ... 480 V
³⁾ Can be directly mounted on solid-state contactor with screw connection

Screw connection: 1
 Spring-loaded connection: 2
 Ring cable lug connection: 4

Screw connection: 1
 Spring-loaded connection: 2

Screw connection: 1
 Spring-loaded connection: 2
 AC/DC 24 V: A
 AC/DC 24 – 240 V: W

Solid-state reversing contactor ²⁾		
Rated operating current	Order no.	Order no.
3.8	3RF3403-1BD04	3RF3403-1BD24
5.4	3RF3405-1BD04	3RF3405-1BD24
7.4	3RF3410-1BD04 ¹⁾	3RF3410-1BD24 ¹⁾

Starter combinations:
motor starter protector,
contactor and overload
relay

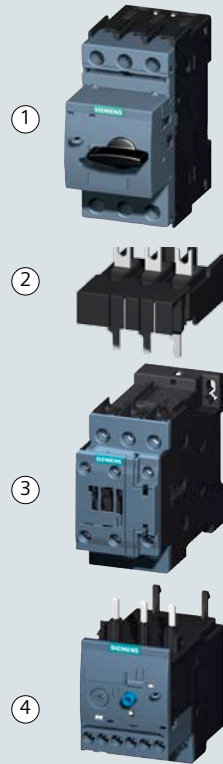

Type	Screw connection	Spring-loaded connection
① Motor starter protector *		
② Link module ¹⁾	AC 3RA2921-1AA00 DC 3RA2921-1BA00	3RA2921-2AA00 3RA2921-2AA00
③ Contactor *		
④ Overload relay *		

* For order numbers of basic components see tabular overview on page 17

¹⁾ Only suitable up to 32 A

Starter combinations:
motor starter protector, contactor with
optional current monitoring relay

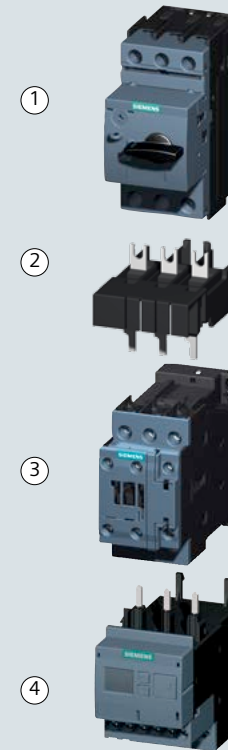

Type	Screw connection	Spring-loaded connection
① Motor starter protector *		
② Link module ¹⁾	AC 3RA2921-1AA00 DC 3RA2921-1BA00	3RA2921-2AA00 3RA2921-2AA00
③ Contactor *		
④ Current monitoring relay *		

* For order numbers of basic components see tabular overview on page 17

¹⁾ Only suitable up to 32 A

Starter combinations:
motor starter protector,
contactor and overload relay

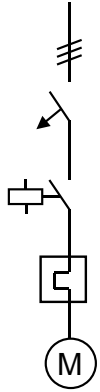

Three-phase motor 400V/AC-3 [kW] [A]		Motor starter protector for starter protection		Contactor			Overload relay				
[kW]	[A]	Thermal overload release	Order no.	Aux. con- tacts	Control supply voltage			Setting range CLASS 10 [A]	Order no. Thermal	Setting range CLASS 10 [A]	Order no. Electronic
					DC 24 V	AC 230 V	UC (AC 50/60 Hz/DC)				
7.5	16	-	3RV2321-4AC□0	1NO+1NC	3RT2025-□BB40	3RT2025-□AP00	3RT2025-□N□30	11 - 16	3RU2126-4A□0		
7.5	20	-	3RV2321-4BC□0					14 - 20	3RU2126-4B□0	6 - 25	3RB3026-1Q□0
11	22	-	3RV2321-4CC□0	1NO+1NC	3RT2026-□BB40	3RT2026-□AP00	3RT2026-□N□30	17 - 22	3RU2126-4C□0		
11	25	-	3RV2321-4DC□0					20 - 25	3RU2126-4D□0		
15	28	-	3RV2321-4NC□0	1NO+1NC	3RT2027-□BB40	3RT2027-□AP00	3RT2027-□N□30	23 - 28	3RU2126-4N□0	10 - 40	3RB3026-1V□0
15	32	-	3RV2321-4EC□0					27 - 32	3RU2126-4E□0		
18.5	36	-	3RV2321-4PC10	1NO+1NC	3RT2028-□BB40	3RT2028-□AP00	3RT2028-□N□30	30 - 36	3RU2126-4P□0		
18.5	40	-	3RV2321-4FC10					34 - 40	3RU2126-4F□0		

Screw connection: 1
Spring-loaded connection ²⁾: 2

Screw connection: 1
Spring-loaded connection: 2
Ring cable lug connection ⁴⁾: 4
UC 21 - 28 V: B
UC 95 - 130 V: F
UC 200 - 280 V: P

Screw connection: B
Spring-loaded connection: C
Ring cable lug connection: J
Screw connection: B
Spring-loaded connection: E

Starter combinations:
motor starter protector,
contactor with optional
current monitoring relay

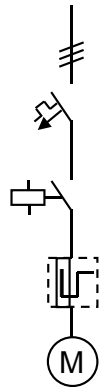

Three-phase motor 400V/AC-3 [kW] [A]		Motor starter protector f. motor protection		Contactor			Current monitoring relay			
[kW]	[A]	Thermal overload release [A]	Order no.	Aux. con- tacts	Control supply voltage			Measure- ment range [A]	Order no. Basic (analog setting)	Order no. Standard (digital setting)
					DC 24 V	AC 230 V	UC (AC 50/60 Hz/DC)			
7.5	16	11 - 16	3RV2021-4AA□0	1NO+1NC	3RT2025-□BB40	3RT2025-□AP00	3RT2025-□N□30			
7.5	20	14 - 20	3RV2021-4BA□0							
11	22	17 - 22	3RV2021-4CA□0	1NO+1NC	3RT2026-□BB40	3RT2026-□AP00	3RT2026-□N□30			
11	25	20 - 25	3RV2021-4DA□0							
15	28	23 - 28	3RV2021-4NA□0	1NO+1NC	3RT2027-□BB40	3RT2027-□AP00	3RT2027-□N□30			
15	32	27 - 32	3RV2021-4EA□0							
18.5	36	30 - 36	3RV2021-4PA10	1NO+1NC	3RT2028-□BB40	3RT2028-□AP00	3RT2028-□N□30	4 - 40	3RR2142-□A□30	3RR2242-□F□30
18.5	40	34 - 40	3RV2021-4FA10							

Screw connection: 1
Spring-loaded connection ²⁾: 2
Ring cable lug connection ²⁾: 4

Screw connection: 1
Spring-loaded connection: 2
Ring cable lug connection ⁴⁾: 4
UC 21 - 28 V: B
UC 95 - 130 V: F
UC 200 - 280 V: P

Screw connection: 1
Spring-loaded connection: 2
AC/DC 24 V: A
AC/DC 24 - 240 V: W

²⁾ Max. 32 A

⁴⁾ Voltages on request

Starter combinations:

motor starter protector, 3RW30 soft starter with optional current monitoring relay (for stand-alone mounting)



① Motor starter protector *

② Link module¹⁾

③ Soft starter *

④ Adapter for stand-alone assembly

⑤ Current monitoring relay *²⁾

Type	Screw connection	Spring-loaded connection
① Motor starter protector *		
② Link module ¹⁾	3RA2921-1BA00	3RA2921-2GA00
③ Soft starter *		
④ Adapter for stand-alone assembly	3RU2926-3AA01	3RU2916-3AC01
⑤ Current monitoring relay * ²⁾		

* For order numbers of basic components see tabular overview on page 19

1) Only suitable up to 32 A
 2) An adapter for stand-alone assembly is required for the application of a 3RR2 current monitoring relay on a 3RW30/40 soft starter. The current monitoring relay must not be active during the start-up and ramp-down phase (phase control).
 For 3RW30: The 3RR2 monitoring relay is to be enabled via an upstream timing relay after soft start-up completion.
 For 3RW40: The 3RR2 monitoring relay is to be enabled/disabled via the BYPASS output (start-up detection).

Starter combinations:

motor starter protector, 3RW40 soft starter (integrated electronic overload relay) with optional current monitoring relay (for stand-alone mounting)

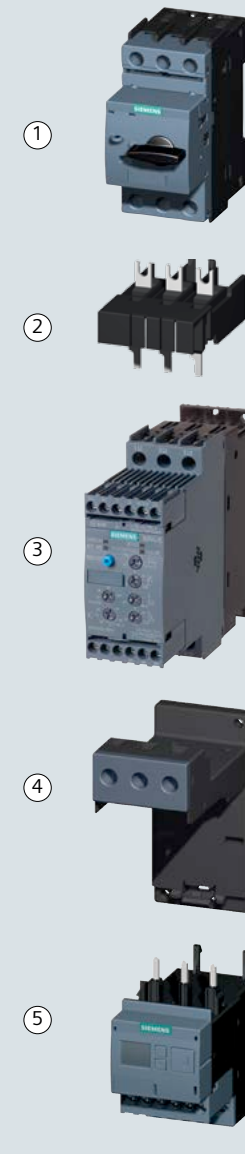

① Motor starter protector *

② Link module¹⁾

③ Soft starter *

④ Adapter for stand-alone assembly

⑤ Current monitoring relay *²⁾

Type	Screw connection	Spring-loaded connection
① Motor starter protector *		
② Link module ¹⁾	3RA2921-1BA00	3RA2921-2GA00
③ Soft starter *		
④ Adapter for stand-alone assembly	3RU2926-3AA01	3RU2916-3AC01
⑤ Current monitoring relay * ²⁾		

* For order numbers of basic components see tabular overview on page 19

1) Only suitable up to 32 A
 2) An adapter for stand-alone assembly is required for the application of a 3RR2 current monitoring relay on a 3RW30/40 soft starter. The current monitoring relay must not be active during the start-up and ramp-down phase (phase control).
 For 3RW30: The 3RR2 monitoring relay is to be enabled via an upstream timing relay after soft start-up completion.
 For 3RW40: The 3RR2 monitoring relay is to be enabled/disabled via the BYPASS output (start-up detection).

Starter combinations: motor starter protector, 3RW30 soft starter with optional current monitoring relay (for stand-alone mounting: see combination options on page 18)



Three-phase motor 400 V/AC-3		Motor starter protector for motor protection		Soft starter ¹⁾			Current monitoring relay		
[kW]	[A]	Setting range, thermal overload release CLASS 10	Order no.	Rated operating current	Order no.	Order no.	Measurement range	Order no. Basic (analog setting)	Order no. Standard (digital setting)
		[A]		[A]	Control supply voltage		[A]		
					AC/DC 24 V	AC/DC 110 – 230 V			
11	22	17 – 22	3RV2021-4CA□0	25	3RW3026-□BB04	3RW3026-□BB14			
11	25	20 – 25	3RV2021-4DA□0						
15	28	23 – 28	3RV2021-4NA□0	32	3RW3027-□BB04	3RW3027-□BB14			
15	32	27 – 32	3RV2021-4EA□0						
18.5	36	30 – 36	3RV2021-4PA10	38	3RW3028-□BB04	3RW3028-□BB14	4 – 40	3RR2142-□A□30	3RR2242-□F□30
18.5	40	34 – 40	3RV2021-4FA10						
18.5	40	34 – 40	3RV2021-4FA10	45	3RW3036-□BB04	3RW3036-□BB14			

Starter combinations: motor starter protector, 3RW40 soft starter (integrated electronic overload relay) with optional current monitoring relay (for stand-alone mounting: see combination options on page 18)



Three-phase motor 400 V/AC-3		Motor starter protector for starter protection		Soft starter ¹⁾			Current monitoring relay		
[kW]	[A]	Setting range of thermal overload release CLASS 10	Order no.	Rated operating current	Order no.	Order no.	Measurement range	Order no. Basic (analog setting)	Order no. Standard (digital setting)
		[A]		[A]	Control supply voltage		[A]		
					AC/DC 24 V	AC/DC 110 – 230 V			
5.5	12.5	–	3RV2311-1KC□0	12.5	3RW4024-□BB04	3RW4024-□BB14			
7.5	16	–	3RV2321-4AC□0						
7.5	20	–	3RV2321-4BC□0						
11	22	–	3RV2321-4CC□0	25	3RW4026-□BB04	3RW4026-□BB14			
11	25	–	3RV2321-4DC□0						
15	28	–	3RV2321-4NC□0						
15	32	–	3RV2321-4EC□0	32	3RW4027-□BB04	3RW4027-□BB14	4 – 40	3RR2142-□A□30	3RR2242-□F□30
18.5	36	–	3RV2321-4PC10						
18.5	40	–	3RV2321-4FC10	38	3RW4028-□BB02	–			

¹⁾ Operating voltage 200 – 480 V

Screw connection: 1
Spring-loaded connection: 2
up to 32 A

Screw connection: 1
Spring-loaded connection: 2

Screw connection: 1
Spring-loaded connection: 2
AC/DC 24 V: A
AC/DC 24 – 240 V: W

Direct start

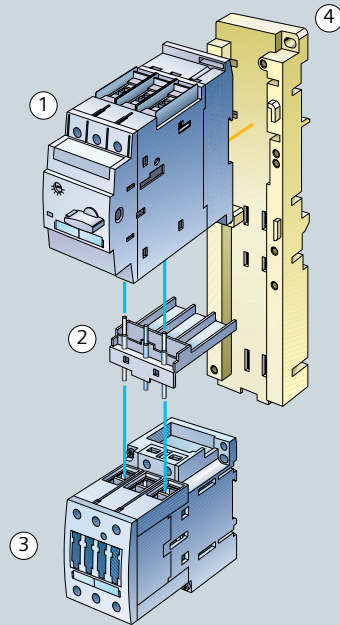

Type	Version	Order no.
① Size S2 circuit breaker		
② Link module	AC DC	3RA19 31-1AA00 3RA19 31-1BA00
③ Size S2 contactors		
For busbar mounting (alternative)		
Busbar adapter	40 mm 60 mm	8US10 61-5FP08 8US12 61-5FP08
For rail mounting (diagram)		
④ Rail adapter		3RA19 32-1AA00

Reversing start

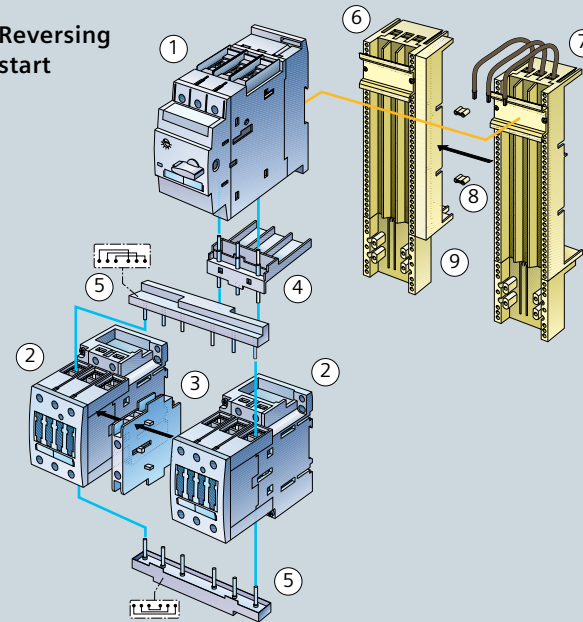

Assembly kit for busbar mounting

40 mm: 3RA19 33-1C
60 mm: 3RA19 33-1D
comprising:

- ⑤ 1 wiring kit
- ⑥ 1 busbar adapter
- ⑦ 1 controlgear support
- ⑨ 1 side module
- ⑧ 2 link wedges

Assembly kit for rail mounting

3RA19 33-1B
comprising:

- ⑤ 1 wiring kit
- 1 rail adapter
- ⑧ 2 side modules
- 4 link wedges

Type	Version	Order no.
① Size S2 circuit breaker		
② 2 Size S2 contactors		
③ Mechanical interlock		3RA19 24-2B
④ Link module	AC DC	3RA19 31-1AA00 3RA19 31-1BA00
⑤ Wiring kit: upper link module, lower link module		
For busbar mounting (diagram)		
⑥ Controlgear support	40 mm 60 mm	8US10 60-5AP00 8US12 60-5AP00
⑦ Busbar adapter	40 mm 60 mm	8US10 61-5FP08 8US12 61-5FP08
⑧ Link wedges (1 Order no. = 100 wedges)		8US19 98-1AA00
⑨ Side module		8US19 98-2MB00
For rail mounting (alternative)		
Rail adapter		3RA19 32-1AA00
Link wedges (1 Order no. = 100 wedges)		8US19 98-1AA00

S2 selection and ordering data



Three-phase motor 400 V/AC-3	Circuit breakers (MSP)		Contactor			Soft starters ¹⁾			Overload relays			
	Setting range CLASS 10	Order no.	Aux. contacts	Control supply voltage	Order no.	Control supply voltage	Rated operating current <i>I_e</i> [A]	Order no.	Setting range CLASS 10	Order no. Thermal	Setting range	Order no. Electronic ²⁾ CLASS 10
[kW] [A]	[A]	[A]							[A]		[A]	
15 29	22 – 32	3RV1031-4EA10	–	AC 230 V, 50/60 Hz	3RT1034-1AL20	AC/DC 110–230 V	45	3RW3036-1BB14	22 – 32	3RU1136-4EBO		
			–	DC 24 V	3RT1034-1BB40	AC/DC 24 V	45	3RW3036-1BB04				
18.5 35	28 – 40	3RV1031-4FA10	–	AC 230 V, 50/60 Hz	3RT1035-1AL20	AC/DC 110–230 V	45	3RW3036-1BB04	28 – 40	3RU1136-4FB0		
			–	DC 24 V	3RT1035-1BB40	AC/DC 24 V	45	3RW4036-1BB14				
22 41	36 – 45	3RV1031-4GA10	–	AC 230 V, 50/60 Hz	3RT1036-1AL20	AC/DC 110–230 V	45	3RW4036-1BB14	36 – 45	3RU1136-4GB0	12.5 – 50	3RB2□3□□UB0
			–	DC 24 V	3RT1036-1BB40	AC/DC 24 V	45	3RW4036-1BB04				
22 41	40 – 50	3RV1031-4HA10	–	AC 230 V, 50/60 Hz	3RT1036-1AL20				40 – 50	3RU1136-4HB0		
			–	DC 24 V	3RT1036-1BB40							

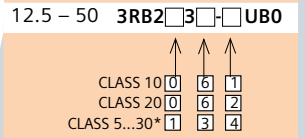

* With ground-fault detection (activatable) and electrical remote reset

¹⁾ Operating voltage 200 – 480 V

²⁾ For using tripping CLASS 20, please refer to the information contained in the "SIRIUS Engineering – Fuseless Load Feeders" configuration brochure and in the catalog

Direct start

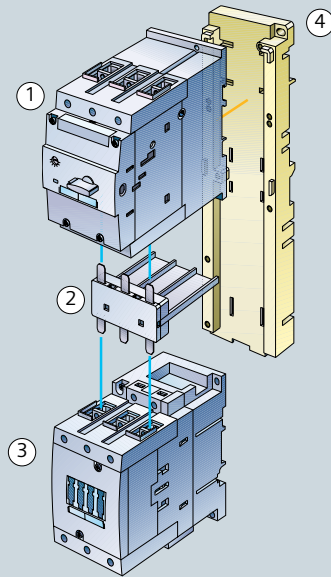

Type	Version	Order no.
① Size S3 circuit breaker		
② Link module	AC DC	3RA19 41-1AA00 3RA19 41-1BA00
③ Size S3 contactor		
④ Rail adapter		3RA19 42-1A

Reversing start

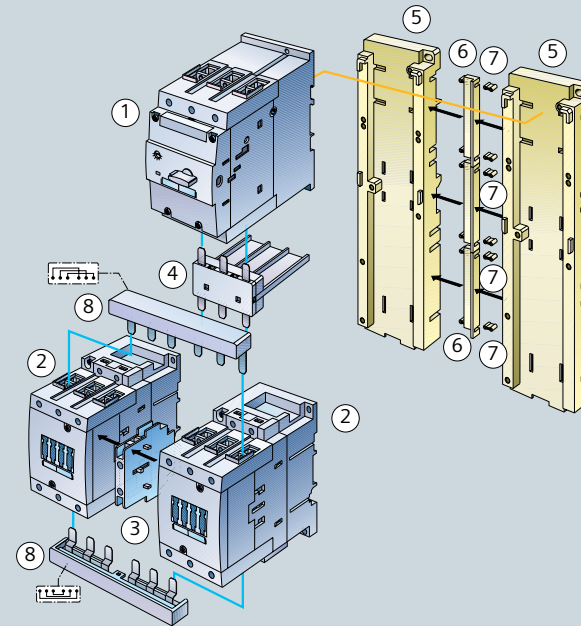

Assembly kit
for rail mounting

3RA19 43-1B
comprising:

- ⑧ 1 wiring kit
- ⑤ 2 rail adapters
- ⑥ 3 side modules
- ⑦ 6 link wedges

Type	Version	Order no.
① Size S3 circuit breaker		
② 2 Size S3 contactors		
③ Mechanical interlock		3RA19 24-2B
④ Link module	AC DC	3RA19 41-1AA00 3RA19 41-1BA00
⑤ Rail adapter		
⑥ Side modules for rail adapters (1 Order no. = 10 adapters)		3RA19 02-1B
⑦ Link wedges (1 Order no. = 100 wedges)		8US19 98-1AA00
⑧ Wiring kit: upper link module, lower link module		3RA19 43-2A

S3 selection and ordering data



Three-phase motor 400 V/AC-3	Circuit breakers (MSP)		Contactor		Soft starters ¹⁾			Overload relays				
	Setting range CLASS 10	Order no.	Aux. con- tacts	Control supply voltage	Order no.	Control supply voltage	Rated operating current <i>I_e</i> [A]	Order no.	Setting range CLASS 10	Order no. Thermal	Setting range	Order no. Electronic ²⁾ CLASS 10
[kW] [A]	[A]	[A]							[A]		[A]	
30 55	42 – 63	3RV1041-4JA10	–	AC 230 V, 50/60 Hz	3RT1044-1AL20	AC/DC 110–230 V	80	3RW3046-1BB14	45 – 63	3RU1146-4JB0		
			–	DC 24 V	3RT1044-1BB40	AC/DC 24 V						
37 67	57 – 75	3RV1041-4KA10		AC 230 V, 50/60 Hz	3RT1045-1AL20	AC/DC 110–230 V	80	3RW3046-1BB04	57 – 75	3RU1146-4KB0		
			–	DC 24 V	3RT1045-1BB40	AC/DC 24 V						
45 80	70 – 90	3RV1041-4LA10		AC 230 V, 50/60 Hz	3RT1046-1AL20	AC/DC 110–230 V	80	3RW4046-1BB14	70 – 90	3RU1146-4LB0	25 – 100	3RB2□4□□EBO
			–	DC 24 V	3RT1046-1BB40	AC/DC 24 V	80	3RW4046-1BB04	80 – 100	3RU1146-4MB0		
45 80	80 – 100	3RV1041-4MA10		AC 230 V, 50/60 Hz	3RT1046-1AL20							
			–	DC 24 V	3RT1046-1BB40							

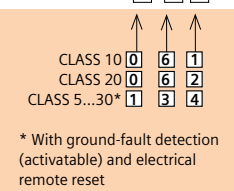

¹⁾ Operating voltage 200 – 480 V

²⁾ For using tripping CLASS 20, please refer to the information contained in the "SIRIUS Engineering – Fuseless Load Feeders" configuration brochure and in the catalog



S6		Contactor					Overload relay ²⁾			Soft starter						
Three-phase motor 400 V/AC-3	Electromagnetic operating mechanism	Aux. switches	Control supply voltage	Order no. contactor	Order no. Vacuum contactor	Setting range	Order no. Solid-state Overload relay	Version	Control supply voltage	Rated operating current	Order no.					
												[kW]	[A]	[AC/DC V]	[A]	le [A]
55	Conventional	2NO + 2NC	220 – 240	3RT1054-1AP36	–	50 – 200	3RB2□5□-□FW2	with straight-through transformer	AC 230 V	134	3RW4055-6BB44					
	Electronic															
	– for 24 V DC PLC output	2NO + 2NC	200 – 277	3RT1054-1NP36	–											
	– for 24 V DC PLC output w/RLT ³⁾	1NO + 1NC	200 – 277	3RT1054-1PP35	–											
	– with AS-i interface and RLT ³⁾	1NO + 1NC	200 – 277	3RT1054-1QP35	–											
75	Conventional	2NO + 2NC	220 – 240	3RT1055-6AP36	–				50 – 200	3RB2□5□-□FC2	with busbar connection	AC 230 V	162	3RW4056-6BB44		
	Electronic															
	– for 24 V DC PLC output	2NO + 2NC	200 – 277	3RT1055-6NP36	–											
	– for 24 V DC PLC output w/RLT ³⁾	1NO + 1NC	200 – 277	3RT1055-6PP35	–											
	– with AS-i interface and RLT ³⁾	1NO + 1NC	200 – 277	3RT1055-6QP35	–											
90	Conventional	2NO + 2NC	220 – 240	3RT1056-6AP36	–							CLASS 10 0 6 1 CLASS 20 0 6 2 CLASS 5...30* 1 3 4	* With ground-fault detection (activatable) and electrical remote reset	AC 230 V	162	3RW4056-6BB44
	Electronic															
	– for 24 V DC PLC output	2NO + 2NC	200 – 277	3RT1056-6NP36	–											
	– for 24 V DC PLC output w/RLT ³⁾	1NO + 1NC	200 – 277	3RT1056-6PP35	–											
	– with AS-i interface and RLT ³⁾	1NO + 1NC	200 – 277	3RT1056-6QP35	–											



S6		Contactor				
110	225	Conventional	2NO+2NC	220 – 240	3RT1064-6AP36	3RT1264-6AP36
Electronic						
– for 24 V DC PLC output		2NO+2NC	200 – 277	3RT1064-6NP36	3RT1264-6NP36	
– for 24 V DC PLC output w/RLT ³⁾		1NO+1NC	200 – 277	3RT1064-6PP35	–	
– with AS-i interface and RLT ³⁾		1NO+1NC	200 – 277	3RT1064-6QP35	–	
132	265	Conventional	2NO+2NC	220 – 240	3RT1065-6AP36	3RT1265-6AP36
Electronic						
– for 24 V DC PLC output		2NO+2NC	200 – 277	3RT1065-6NP36	3RT1265-6NP36	
– for 24 V DC PLC output w/RLT ³⁾		1NO+1NC	200 – 277	3RT1065-6PP35	–	
– with AS-i interface and RLT ³⁾		1NO+1NC	200 – 277	3RT1065-6QP35	–	
160	300	Conventional	2NO+2NC	220 – 240	3RT1066-6AP36	3RT1266-6AP36
Electronic						
– for 24 V DC PLC output		2NO+2NC	200 – 277	3RT1066-6NP36	3RT1266-6NP36	
– for 24 V DC PLC output w/RLT ³⁾		1NO+1NC	200 – 277	3RT1066-6PP35	–	
– with AS-i interface and RLT ³⁾		1NO+1NC	200 – 277	3RT1066-6QP35	–	



Overload relay ²⁾	
55 – 250	3RB2 □6□□□GC2 with busbar connection
160 – 630	3RB2 □6□□□MC2 with busbar connection

CLASS 10	0	6	1
CLASS 20	0	6	2
CLASS 5...30*	1	3	4

* With ground-fault detection (activatable) and electrical remote reset

Soft starter		
AC 230 V	230	3RW4073-6BB44
AC 115 V	230	3RW4073-6BB34
AC 230 V	280	3RW4074-6BB44
AC 115 V	280	3RW4074-6BB34

S12		Contactor				
220	400	Conventional	2NO+2NC	220 – 240	3RT1075-6AP36	3RT1275-6AP36
Electronic						
– for 24 V DC PLC output		2NO+2NC	200 – 277	3RT1075-6NP36	3RT1275-6NP36	
– for 24 V DC PLC output w/RLT ³⁾		1NO+1NC	200 – 277	3RT1075-6PP35	–	
– with AS-i interface and RLT ³⁾		1NO+1NC	200 – 277	3RT1075-6QP35	–	
250	500	Conventional	2NO+2NC	220 – 240	3RT1076-6AP36	3RT1276-6AP36
Electronic						
– for 24 V DC PLC output		2NO+2NC	200 – 277	3RT1076-6NP36	3RT1276-6NP36	
– for 24 V DC PLC output w/RLT ³⁾		1NO+1NC	200 – 277	3RT1076-6PP35	–	
– with AS-i interface and RLT ³⁾		1NO+1NC	200 – 277	3RT1076-6QP35	–	

Overload relay ²⁾	
160 – 630	3RB2 □6□□□MC2 with busbar connection

CLASS 10	0	6	1
CLASS 20	0	6	2
CLASS 5...30*	1	3	4

* With ground-fault detection (activatable) and electrical remote reset

Soft starter		
AC 230 V	356	3RW4075-6BB44
AC 115 V	356	3RW4075-6BB34
AC 230 V	432	3RW4076-6BB44
AC 115 V	432	3RW4076-6BB34



For applications above 100 A, SIRIUS contactors can be combined with SENTRON 3VL circuit breakers. For more detailed information please refer to the engineering brochure "Engineering SIRIUS fuseless load feeders."

¹⁾ For rated device operating voltage Ue: 200–460 V (see catalog for Ue: 400–600 V)

²⁾ For using tripping CLASS 20, please refer to the information contained in the "SIRIUS Engineering – Fuseless Load Feeders" configuration brochure and in the catalog

³⁾ RLT: Remaining lifetime indication

SENTRON 3VL circuit breakers are suitable for the fuseless short-circuit and overload protection of soft starters of size S6 or larger. For further information, please refer to the catalog.

Direct starter,
fully preassembled,
electromechanical



Three-phase motor 400 V/AC-3		Setting range of thermal overload release	3RA21 direct-on-line starter Coordination type 1	3RA21 direct-on-line starter Coordination type 2	3RA61 Compact Starter Setting range of thermal overload release	Coordination type 2 CPS ¹⁾
[kW]	[A]	[A]			[A]	
0.06	0.20	0.14 – 0.2	3RA2110-0B □ 15-1 □ □ □ S00	3RA2110-0B □ 15-1 □ □ □ S00	0.1 – 0.4	3RA6120-□ A □ 3 □
0.06	0.25	0.18 – 0.25	3RA2110-0C □ 15-1 □ □ □ S00	3RA2110-0C □ 15-1 □ □ □ S00		
0.09	0.32	0.22 – 0.32	3RA2110-0D □ 15-1 □ □ □ S00	3RA2110-0D □ 15-1 □ □ □ S00	0.32 – 1.25	3RA6120-□ B □ 3 □
0.09	0.40	0.28 – 0.4	3RA2110-0E □ 15-1 □ □ □ S00	3RA2110-0E □ 15-1 □ □ □ S00		
0.12	0.50	0.35 – 0.5	3RA2110-0F □ 15-1 □ □ □ S00	3RA2110-0F □ 15-1 □ □ □ S00		
0.18	0.63	0.45 – 0.63	3RA2110-0G □ 15-1 □ □ □ S00	3RA2110-0G □ 15-1 □ □ □ S00		
0.18	0.80	0.55 – 0.8	3RA2110-0H □ 15-1 □ □ □ S00	3RA2110-0H □ 15-1 □ □ □ S00	1 – 4	3RA6120-□ C □ 3 □
0.25	1.0	0.7 – 1	3RA2110-0J □ 15-1 □ □ □ S00	3RA2110-0J □ 15-1 □ □ □ S00		
0.37	1.25	0.9 – 1.25	3RA2110-0K □ 15-1 □ □ □ S00	3RA2110-0K □ 15-1 □ □ □ S00	3 – 12	3RA6120-□ D □ 3 □
0.55	1.6	1.1 – 1.6	3RA2110-1A □ 15-1 □ □ □ S00	3RA2110-1A □ 15-1 □ □ □ S00		
0.75	2.0	1.4 – 2	3RA2110-1B □ 15-1 □ □ □ S00	3RA2110-1B □ 15-1 □ □ □ S00		
0.75	2.5	1.8 – 2.5	3RA2110-1C □ 15-1 □ □ □ S00	3RA2110-1C □ 15-1 □ □ □ S00		
1.1	3.2	2.2 – 3.2	3RA2110-1D □ 15-1 □ □ □ S00	3RA2110-1D □ 15-1 □ □ □ S00	8 – 32	3RA6120-□ E □ 3 □
1.5	4.0	2.8 – 4	3RA2110-1E □ 15-1 □ □ □ S00	3RA2110-1E □ 15-1 □ □ □ S00		
1.5	5.0	3.5 – 5	3RA2110-1F □ 15-1 □ □ □ S00	3RA2120-1F □ 24-0 □ □ □ S0 ³⁾		
2.2	6.3	4.5 – 6.3	3RA2110-1G □ 15-1 □ □ □ S00	3RA2120-1G □ 24-0 □ □ □ S0 ³⁾		
3	8	5.5 – 8	3RA2110-1H □ 15-1 □ □ □ S00	3RA2120-1H □ 24-0 □ □ □ S0 ³⁾		
4	10	7 – 10	3RA2110-1J □ 16-1 □ □ □ S00	3RA2120-1J □ 26-0 □ □ □ S0 ³⁾		
5.5	12.5	9 – 12.5	3RA2110-1K □ 17-1 □ □ □ S00	3RA2120-1K □ 26-0 □ □ □ S0 ³⁾		
7.5	16	11 – 16	3RA2110-4A □ 18-1 □ □ □ S00	3RA2120-4A □ 26-0 □ □ □ S0		
7.5	20	14 – 20	3RA2120-4B □ 26-0 □ □ □ S0	3RA2120-4B □ 26-0 □ □ □ S0		
11	22	17 – 22	3RA2120-4C □ 27-0 □ □ □ S0	3RA2120-4C □ 27-0 □ □ □ S0		
11	25	20 – 25	3RA2120-4D □ 27-0 □ □ □ S0	3RA2120-4D □ 27-0 □ □ □ S0		
15	32	27 – 32	3RA2120-4E □ 27-0 □ □ □ S0	3RA2120-4E □ 27-0 □ □ □ S0		

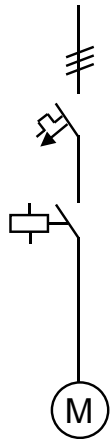

¹⁾ CPS: Control and protective switching device, IEC/EN 60947-6-2

²⁾ If used in the 3RA68 Infeed system, please use 3 instead of 2.

³⁾ Not available with spring-loaded connection system

Screw connection (for mounting onto DIN rail): **A**
 Spring-loaded connection (for mounting onto DIN rail): **E**
 Screw connection (busbar adapter): **D**
 Spring-loaded connection (busbar adapter): **H**

24 V AC/DC: **B B 4**
 230 V AC: **A P O**

Without terminals: **0** **0**
 With screw connection: **1** **2**²⁾
 With spring-loaded connection: **2** **2**²⁾
 24 V AC/DC: **B**
 AC 110 ... 240 V AC/DC: **P**

Reversing starter,
fully preassembled

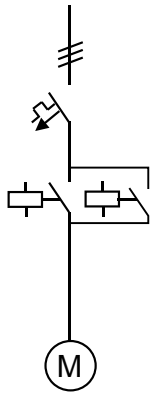

Three-phase motor 400 V/AC-3		Setting range of thermal overload release	3RA22 reversing starter Coordination type 1	3RA22 reversing starter Coordination type 2	3RA62 Compact Starter Setting range of thermal overload release [A]	Coordination type 2 CPS ¹⁾
[kW]	[A]	[A]				
0.06	0.20	0.14 – 0.2	3RA2210-0B □ 15-2 □ □ □ S00	3RA2210-0B □ 15-2 □ □ □ S00		
0.06	0.25	0.18 – 0.25	3RA2210-0C □ 15-2 □ □ □ S00	3RA2210-0C □ 15-2 □ □ □ S00	0.1 – 0.4	3RA6250-□ A □ 3 □
0.09	0.32	0.22 – 0.32	3RA2210-0D □ 15-2 □ □ □ S00	3RA2210-0D □ 15-2 □ □ □ S00		
0.09	0.40	0.28 – 0.4	3RA2210-0E □ 15-2 □ □ □ S00	3RA2210-0E □ 15-2 □ □ □ S00		
0.12	0.50	0.35 – 0.5	3RA2210-0F □ 15-2 □ □ □ S00	3RA2210-0F □ 15-2 □ □ □ S00		
0.18	0.63	0.45 – 0.63	3RA2210-0G □ 15-2 □ □ □ S00	3RA2210-0G □ 15-2 □ □ □ S00		
0.18	0.80	0.55 – 0.8	3RA2210-0H □ 15-2 □ □ □ S00	3RA2210-0H □ 15-2 □ □ □ S00	0.32 – 1.25	3RA6250-□ B □ 3 □
0.25	1.0	0.7 – 1	3RA2210-0J □ 15-2 □ □ □ S00	3RA2210-0J □ 15-2 □ □ □ S00		
0.37	1.25	0.9 – 1.25	3RA2210-0K □ 15-2 □ □ □ S00	3RA2210-0K □ 15-2 □ □ □ S00		
0.55	1.6	1.1 – 1.6	3RA2210-1A □ 15-2 □ □ □ S00	3RA2210-1A □ 15-2 □ □ □ S00		
0.75	2.0	1.4 – 2	3RA2210-1B □ 15-2 □ □ □ S00	3RA2210-1B □ 15-2 □ □ □ S00	1 – 4	3RA6250-□ C □ 3 □
0.75	2.5	1.8 – 2.5	3RA2210-1C □ 15-2 □ □ □ S00	3RA2210-1C □ 15-2 □ □ □ S00		
1.1	3.2	2.2 – 3.2	3RA2210-1D □ 15-2 □ □ □ S00	3RA2210-1D □ 15-2 □ □ □ S00		
1.5	4.0	2.8 – 4	3RA2210-1E □ 15-2 □ □ □ S00	3RA2210-1E □ 15-2 □ □ □ S00		
1.5	5.0	3.5 – 5	3RA2210-1F □ 15-2 □ □ □ S00	3RA2220-1F □ 24-2 □ □ □ S0 ³⁾		
2.2	6.3	4.5 – 6.3	3RA2210-1G □ 15-2 □ □ □ S00	3RA2220-1G □ 24-0 □ □ □ S0 ³⁾	3 – 12	3RA6250-□ D □ 3 □
3	8	5.5 – 8	3RA2210-1H □ 15-2 □ □ □ S00	3RA2220-1H □ 24-0 □ □ □ S0 ³⁾		
4	10	7 – 10	3RA2210-1J □ 16-2 □ □ □ S00	3RA2220-1J □ 26-0 □ □ □ S0 ³⁾		
5.5	12.5	9 – 12.5	3RA2210-1K □ 17-2 □ □ □ S00	3RA2220-1K □ 26-0 □ □ □ S0 ³⁾		
7.5	16	11 – 16	3RA2210-4A □ 18-2 □ □ □ S00	3RA2220-4A □ 26-0 □ □ □ S0		
7.5	20	14 – 20	3RA2220-4B □ 26-0 □ □ □ S0	3RA2220-4B □ 26-0 □ □ □ S0		
11	22	17 – 22	3RA2220-4C □ 27-0 □ □ □ S0	3RA2220-4C □ 27-0 □ □ □ S0	8 – 32	3RA6250-□ E □ 3 □
11	25	20 – 25	3RA2220-4D □ 27-0 □ □ □ S0	3RA2220-4D □ 27-0 □ □ □ S0		
15	28	23 – 28	3RA2220-4N □ 28-0 □ □ □ S0	3RA2220-4N □ 28-0 □ □ □ S0		
15	32	27 – 32	3RA2220-4E □ 28-0 □ □ □ S0	3RA2220-4E □ 28-0 □ □ □ S0		

¹⁾ CPS: Control and protective switching device, IEC/EN 60947-6-2

²⁾ If used in the 3RA68 Infeed system, please use 3 instead of 2.

³⁾ Not available with spring-loaded connection system

- Screw connection (for mounting onto DIN rail) S00: **A**
- Screw connection (for mounting onto DIN rail) S0: **B**
- Spring-loaded connection (for mounting onto DIN rail) S00: **E**
- Spring-loaded connection (for mounting onto DIN rail) S0: **F**
- Screw connection (busbar adapter): **D**
- Spring-loaded connection (busbar adapter): **H**
- 24 V AC/DC: **B** **B** **4**
- 230 V AC: **A** **P** **0**

- Without terminals: **0** **0**
- With screw connection: **1** **2** ²⁾
- With spring-loaded connection: **2** **2** ²⁾
- 24 V AC/DC **B**
- AC 110 ... 240 V AC/DC **P**

Interfacing load feeders to the control system requires function modules for IO-Link or AS-i which are mounted on contactors (24 V DC) with a communication interface. Depending on the version, they communicate with an IO-Link interface group or any AS-i Master.

Typical layout in the environment of IO-Link

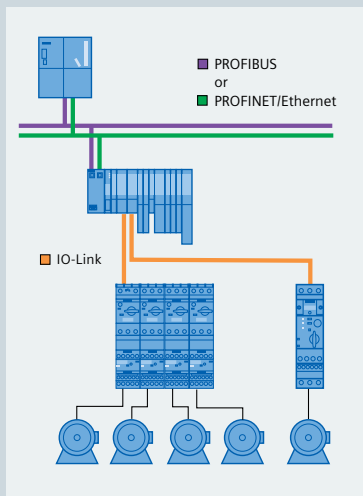

IO-Link	
Version	Order no.
ET 200S electronic module, 4SI IO-Link (with 4 ports for 4 load feeders each)	6ES7 138-4GA50-0AB0
or	
ET 200S electronic module, 4SI SIRIUS (with 4 ports for 4 load feeders each)	3RK1005-0LB00-0AA0
ET 200S terminal module (15 mm wide)	
– With screw terminal	TM-E15S26-A1 6ES7
– With spring-loaded terminal	TM-E15C26-A1 6ES7
– With Fast Connect	TM-E15N26-A1 6ES7
ET 200S interface module for interfacing to PROFIBUS and PROFINET and more system accessories	see the Industry Mall or the IKPI Catalog

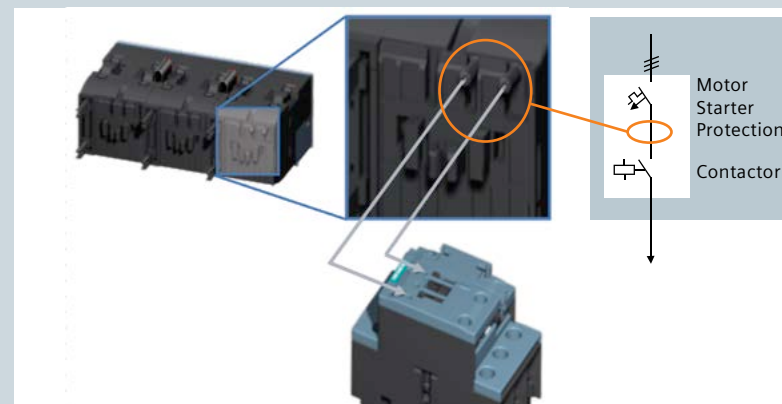

Mounting principle of function modules on contactors



Typical layout in the environment of AS-Interface

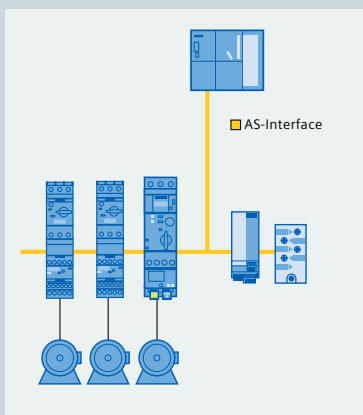

AS-Interface	
Version	Order no.
CP 343-2P communication processor for interfacing SIMATIC S7-300 to AS-Interface (AS-i Spec.3.0) for max. 62 load feeders	6GK7343-2AH11-0XA0
Front connector, 20-pin with screw contacts	6ES7392-1AJ00-0AA0
Front connector, 20-pin with spring-loaded contacts	6ES7392-1BJ00-0AA0
DPI/AS-i LINK Advanced, gateway between PROFIBUS DP and AS-Interface	
– Single master for max. 62 load feeders	6GK1415-2BA10
– Double master for max. 124 load feeders	6GK1415-2BA20
IE/AS-i LINK PN IO, gateway between PROFINET and AS-Interface	
Single master for max. 62 load feeders	6GK1411-2AB10
Double master for max. 124 load feeders	6GK1411-2AB20
AS-Interface power supply unit IP20	
– 120/230 V AC 3A	3RX9501-0BA00
– 24 V DC 3A	3RX9501-1BA00
– 120/230 V AC 5A	3RX9502-0BA00
– 120/230 V AC 8A	3RX9503-0BA00
For more system components for AS-Interface	see the Industry Mall or the IKPI Catalog

Three-phase motor 400 V/AC-3



[kW]	[A]
3	7
4	9
5.5	12
7.5	16
5.5	12
7.5	16
11	25
15	32
18.5	38

S00 contactor with communication interface

Auxiliary contacts	Control supply voltage Order no. DC 24 V
1NC	3RT2015-□BB42-0CC0
1NO	3RT2015-□BB41-0CC0
1NC	3RT2016-□BB42-0CC0
1NO	3RT2016-□BB41-0CC0
1NC	3RT2017-□BB42-0CC0
1NO	3RT2017-□BB41-0CC0
1NC	3RT2018-□BB42-0CC0
1NO	3RT2018-□BB41-0CC0

S0 contactor with communication interface

1NO+1NC	3RT2024-□BB40-0CC0
1NO+1NC	3RT2025-□BB40-0CC0
1NO+1NC	3RT2026-□BB40-0CC0
1NO+1NC	3RT2027-□BB40-0CC0
1NO+1NC	3RT2028-□BB40-0CC0

Screw connection: 
 Spring-loaded connection: 

Function modules for mounting on 3RT2 contactors and for interfacing the control system

Parallel wiring	IO-Link	AS-Interface
		
Direct-on-line start	Direct-on-line start^{1) 2)}	Direct-on-line start^{1) 2)}
Order no.	Order no.	Order no.
ON delay OFF delay (with auxiliary voltage)	Function module	Function module
3RA2811-□CW10 3RA2812-□DW10	3RA2711-□AA00	3RA2712-□AA00
Reversing start	Reversing start^{1) 2) 3)}	Reversing start^{1) 2) 3)}
Order no.	Order no.	Order no.
Wiring kit for contactors Wiring kit for contactors with screw connection	Function module Wiring kit for contactors Wiring kit for contactors	Function module Wiring kit for contactors Wiring kit for contactors
S00 S0	S00 S0	S00 S0
3RA2913-2AA□ 3RA2923-2AA□	3RA2711-□BA00 3RA2913-2AA□ 3RA2923-2AA□	3RA2712-□BA00 3RA2913-2AA□ 3RA2923-2AA□
Star-delta start	Star-delta start^{1) 2) 4)}	Star-delta start^{1) 2) 4)}
Order no.	Order no.	Order no.
Function module ⁴⁾ Wiring kit for contactors ¹⁾ Wiring kit for contactors ¹⁾	Function module Wiring kit for contactors Wiring kit for contactors	Function module Wiring kit for contactors Wiring kit for contactors
3RA2816-0EW20 S00 S0	S00 S0	S00 S0
3RA2913-2BB□ 3RA2923-2BB□	3RA2913-2BB□ 3RA2923-2BB□	3RA2913-2BB□ 3RA2923-2BB□

↑
Screw connection: 1
Spring-loaded connection: 2

↑ ↑
Screw connection: 1
Spring-loaded connection: 2

↑ ↑
Screw connection: 1
Spring-loaded connection: 2

The above shown contactor assemblies can be combined with motor starter protector, overload and current monitoring relay (see the descriptions on previous pages)

¹⁾ The wiring modules for control circuit are not required when using function modules with communications interface

²⁾ The contactor upon which the basic module is fitted must be selected as a communication contactor (see page 28)

³⁾ Consisting of 1 basic module and 1 interface module

⁴⁾ Consisting of 1 basic module and 2 interface modules

IO-Link

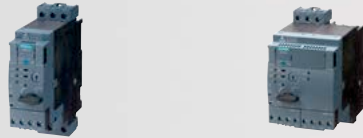

Setting range of thermal overload release

[A]

0.1 – 0.4

0.32 – 1.25

1 – 4

3 – 12

8 – 32

3RA64 direct-on-line starter

Coordination type 2 / CPS¹⁾

AC/DC 24 V

3RA6400- □AB42

3RA6400- □BB42

3RA6400- □CB42

3RA6400- □DB42

3RA6400- □EB42

3RA65 reversing starter

Coordination type 2 / CPS¹⁾

AC/DC 24 V

3RA6500- □AB42

3RA6500- □BB42

3RA6500- □CB42

3RA6500- □DB42

3RA6500- □EB42

Accessories for Compact Starter with IO-Link and 3RA27 function module

Ribbon cable, 14-pin, 8 cm, for small gaps between two contactors

3RA2711-0EE02

Module connector, 14-pin, 21 cm, for wider gaps between two contactors

3RA2711-0EE03

Control module, (incl. enabling chip and blanking cover)

3RA6935-0A

Connecting cable for control module

3RA6933-0A

AS-Interface



Setting range of thermal overload release

[A]

0.1 – 0.4

0.32 – 1.25

1 – 4

3 – 12

8 – 32

3RA61 direct-on-line starter

Coordination type 2 / CPS¹⁾

AC/DC 24 V

3RA6120- □AB34

3RA6120- □BB34

3RA6120- □CB34

3RA6120- □DB34

3RA6120- □EB34

3RA62 reversing starter

Coordination type 2 / CPS¹⁾

AC/DC 24 V

3RA6250- □AB34

3RA6250- □BB34

3RA6250- □CB34

3RA6250- □DB34

3RA6250- □EB34



Accessories for AS-Interface

AS-i addressing unit

3RK1904-2AB01

AS-Interface add-on modules for 3RA6 Compact Starter (DC 24 V)

Without additional inputs/outputs

3RA6970-3A

With two local inputs

3RA6970-3B

With two unassigned external inputs

3RA6970-3C

With one unassigned external input and output each

3RA6970-3D

With two unassigned external outputs

3RA6970-3E

For on-site control

3RA6970-3F

¹⁾ CPS: Control and protective switching device, IEC/EN 60947-6-2

Screw connection: 1
Spring-loaded connection: 2

3RA68 Infeed system (Compact Starter)

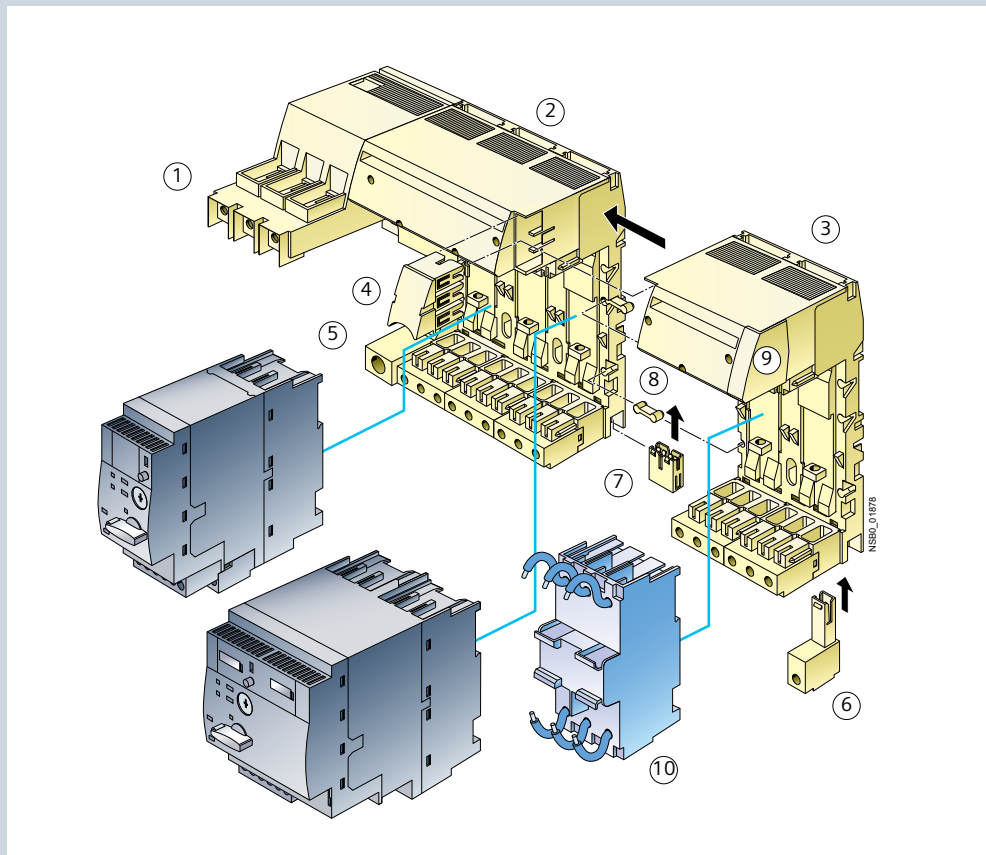

Items 6 and 9 already included in the scope of delivery

	Type	Terminal type	Order no.
①	3-phase feeders		
	Screw feeding 25/35 mm ² left with fixed-mounted triple expansion module	Screw connection	3RA6812-8AB
	Screw feeding 25/35 mm ² left with fixed-mounted triple expansion module	Spring-loaded connection	3RA6812-8AC
	Screw feeding 50–70 mm ² left with fixed-mounted triple expansion module	Screw connection	3RA6813-8AB
	Screw feeding 50–70 mm ² left with fixed-mounted triple expansion module	Spring-loaded connection	3RA6813-8AC
	Spring-loaded feeding 25/35 mm ² left or right up to 63 A		3RA6830-5AC
	Expansion module		
③	Dual expansion module with 2 slots	Screw connection	3RA6822-0AB
②	Triple expansion module with 3 slots	Screw connection	3RA6823-0AB
	Dual expansion module with 2 slots	Spring-loaded connection	3RA6822-0AC
	Triple expansion module with 3 slots	Spring-loaded connection	3RA6823-0AC
④	Expansion plug		
	Expansion plug between 2 expansion modules (already included in the delivery scope of the expansion modules)		
⑤	PE supply		
	PE supply 25/35 mm ²	Screw connection	3RA6860-6AB
	PE supply 25/35 mm ²	Spring-loaded connection	3RA6860-5AC
⑥	PE tap		
	PE tap 6/10 mm ²	Screw connection	3RA6870-4AB
	PE tap 6/10 mm ²	Spring-loaded connection	3RA6870-3AC
⑦	PE expansion plug		3RA6890-0EA
⑧	Link wedge (already included in the scope of supply of ② and ③)		
⑨	Cover cap of the energy bus (already included in the scope of supply of ①)		
	Adapter for SIRIUS 3RV2 motor starter protector		
⑩	Adapter 45 mm for 3RV2 for motor starter protector with screw connection		3RA6890-0BA
	Expansion plug for SIRIUS 3RV19 Infeed system		3RA6890-1AA
	Terminal block to integrate 1-, 2- or 3-pole components	Spring-loaded connection	3RV1917-5D

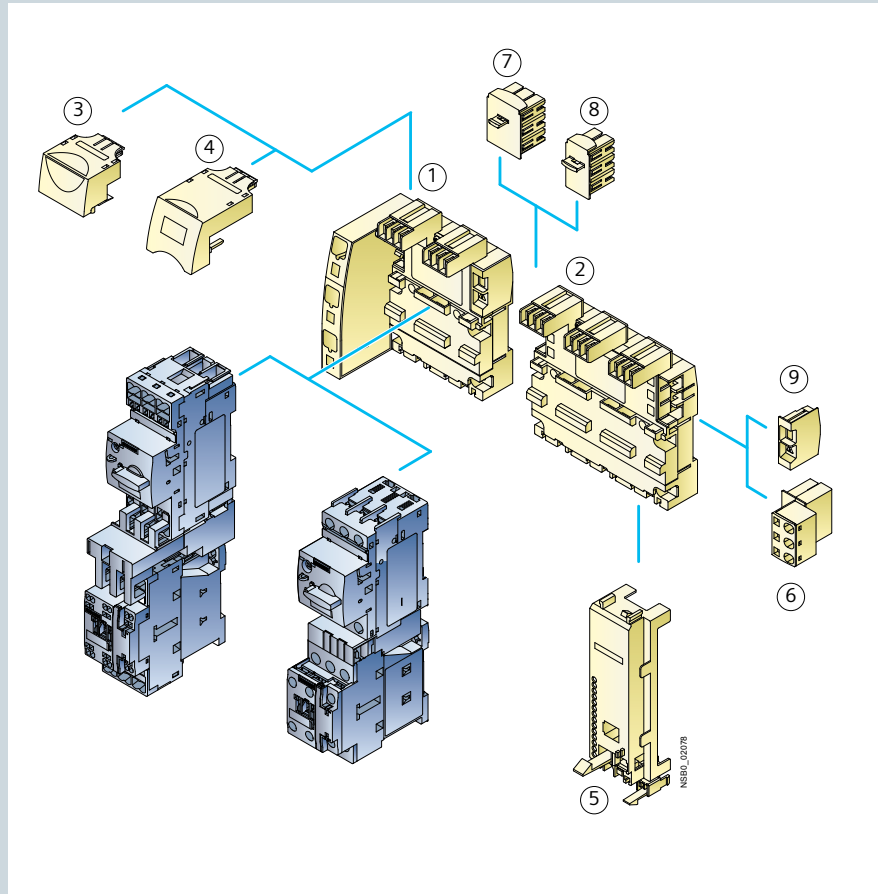

Type	Version	Size for 3RV20, 3RV23 motor starter protectors	Order no.
1 3-phase busbars			
with infeed on the left incl. end cover 3RV2917-6A	For 2 motor starter protectors	S00, S0	3RV2917-1A
with infeed on the right incl. end cover 3RV2917-6A	For 2 motor starter protectors	S00, S0	3RV2917-1E
For system expansion incl. expansion plug 3RV2917-5BA00	For 2 motor starter protectors	S00, S0	3RV2917-4A
2 For system expansion incl. expansion plug 3RV2917-5BA00	For 3 motor starter protectors	S00, S0	3RV2917-4B
Connector			
3 For contacting the motor starter protectors	Screw connection	1 pc. S00	3RV2917-5CA00
	Spring-loaded connection	10 pcs. S00	3RV2917-5C
	Screw connection	1 pc. S00	3RV2917-5AA00
	Spring-loaded connection	10 pcs. S00	3RV2917-5A
	Screw connection	1 pc. S0	3RV1927-5AA00
	Spring-loaded connection	10 pcs. S0	3RV1927-5A
4 Accessories			
5 Contactor base for building up direct-on-line or reversing starters	1 pc.	S00, S0	3RV2927-7AA00
6 Terminal block to integrate 1-, 2- or 3-pole components			3RV2917-5D
DIN rail , 45 mm, to integrate other devices into the system, such as 5SY motor starter protectors			3RV1917-7B
7 Wider expansion plug			3RV2917-5E
Spare parts			
8 Expansion plug			3RV2917-5BA00
9 End cover			3RV2917-6A

3-phase comb busbars / 8US busbar adapters for supply

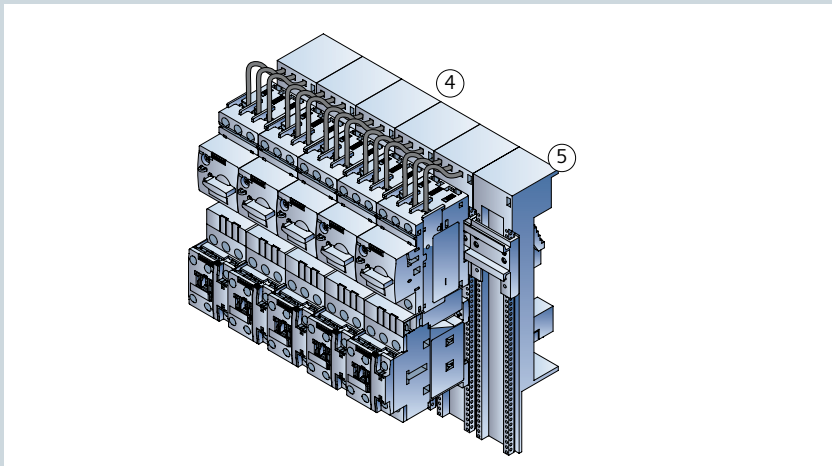
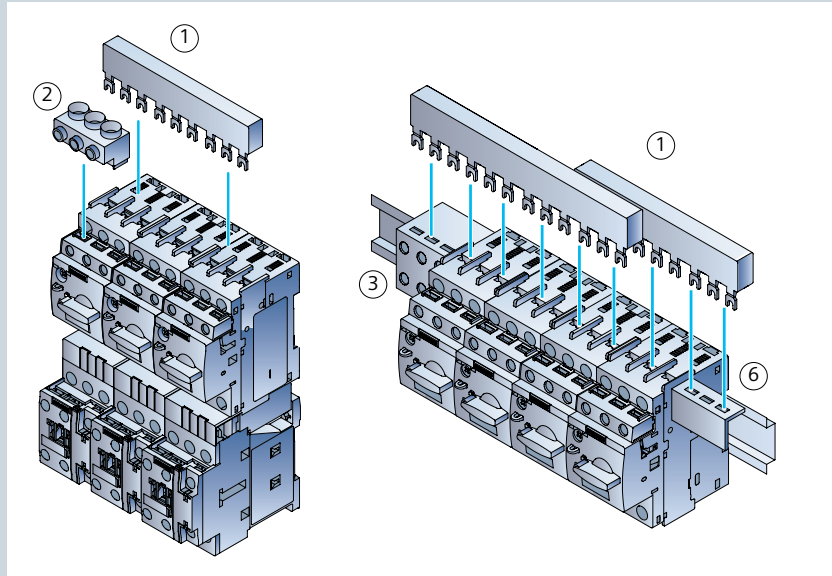

Type	Size	Order no.			
① 3-phase comb busbars					
For supplying several 3RV2 motor starter protectors (screw-connected) mounted side by side on DIN rails, safe to touch			Modular spacing	Modular spacing	Modular spacing
			45 mm	55 mm	63 mm
For 2 motor starter protectors	S00, S0	3RV1915-1AB	3RV1915-2AB	3RV1915-3AB	
For 3 motor starter protectors	S00, S0	3RV1915-1BB	3RV1915-2BB	-	
For 4 motor starter protectors	S00, S0	3RV1915-1CB	3RV1915-2CB	3RV1915-3CB	
For 5 motor starter protectors	S00, S0	3RV1915-1DB	3RV1915-2DB	-	
3-phase supply terminals					
② Connection from the top		S00, S0	3RV2925-5AB		
③ Connection from the bottom		S00, S0	3RV2915-5B		
3-phase supply terminals to build up "type E starters"					
Connection from the top		S00, S0	3RV2925-5EB		
Accessories					
⑥ Cover caps for connecting lugs		S00, S0	3RV1915-6AB		
Touch protection for unassigned slots					

Type	Size	Version (Length)	Order no.
④ Busbar adapter for 60 mm system			
For load feeders	S00	200 mm	8US1251-5DS10
Rated current 16 A for screw connection			
For load feeders	S0	260 mm	8US1251-5NT10
Rated current 32 A for screw connection			
For load feeders	S00, S0	260 mm	8US1251-5DT11
Rated current 16 A for spring-loaded connection			
For load feeders	S0	260 mm	8US1251-5NT11
Rated current 32 A for spring-loaded connection			
⑤ Accessories			
Support		200 mm	8US1250-5AS10
for side mounting on busbar adapter, 45 mm wide			
Support		260 mm	8US1250-5AT10
for side mounting on busbar adapter, 45 mm wide			
Side module		200 mm	8US1998-2BJ10
to widen the busbar adapter, 9 mm wide			
Spacer			8US1998-1BA10
Fixes the load feeder on the adapter			
Vibration/shock kit			8US1998-1CA10
To compensate strain from higher vibration and shock			

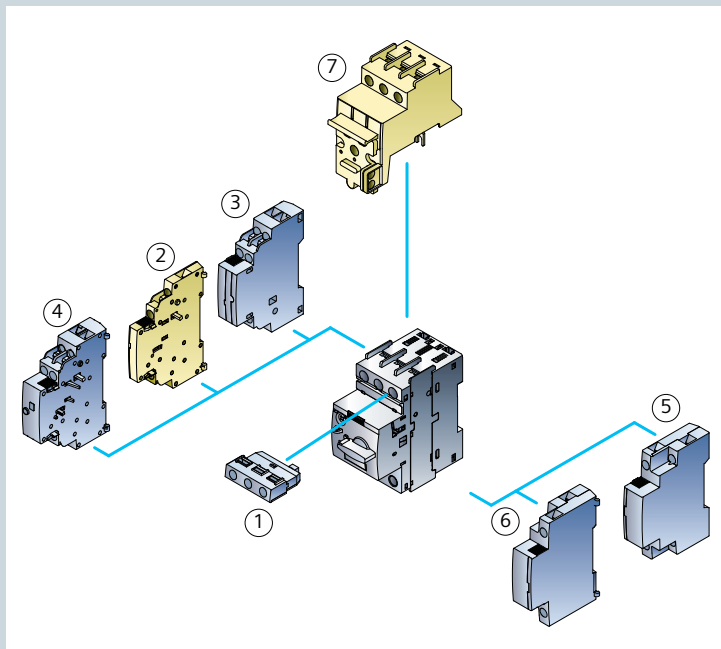

Type	Version	Order no. Screw connection	Order no. Spring-loaded connection	Order no. Ring cable lug connection
Accessories for 3RV2 motor starter protector, size S00, S0				
Auxiliary and signaling contacts				
① Front-mounted auxiliary block	1CO	3RV2901-1D	–	–
	1NO + 1NC	3RV2901-1E	3RV2901-2E	3RV2901-4E
	2NO	3RV2901-1F	3RV2901-2F	–
Auxiliary switch suited for electronic components		1CO	3RV2901-1G	–
② Side-mounted auxiliary block with 2 contacts	1NO + 1NC	3RV2901-1A	3RV2901-2A	3RV2901-4A
	2NO	3RV2901-1B	3RV2901-2B	–
	2NC	3RV2901-1C	3RV2901-2C	–
③ Side-mounted auxiliary block with 4 contacts	2NO + 2NC	3RV2901-1J	–	–
④ Signaling switch		3RV2921-1M	3RV2921-2M	3RV2921-4M
Auxiliary release				
⑤ Shunt trip ¹⁾	AC/DC 20 – 70 V	3RV2902-1DB0	3RV2902-2DB0	–
	AC 210 – 240 V	3RV2902-1DP0	3RV2902-2DP0	–
⑥ Undervoltage release ¹⁾	AC 230 V	3RV2902-1AP0	3RV2902-2AP0	3RV2902-4AP0
	AC 400 V	3RV2902-1AV0	3RV2902-2AV0	3RV2902-4AV0
	Undervoltage release with leading auxiliary contacts	AC 230 V	3RV2922-1CP0	3RV2922-2CP0
	AC 400 V	3RV2922-1CV0	3RV2922-2CV0	–
	AC 415 V	3RV2922-1CV1	3RV2922-2CV1	3RV2922-4CV1
Disconnecter module and terminal blocks				
⑦ Disconnecter module		3RV2928-1A	–	–
	Terminal block type E for higher creepage distances and air clearances	3RV2928-1H	–	–
Phase barriers for higher creepage distances and air clearances		3RV2928-1K	–	–
Rotary door-coupling operating mechanisms				
Rotary door-coupling operating mechanism (black) with				
Extension shaft			130 mm	3RV2926-0B
Extension shaft			330 mm	3RV2926-0K
EMERGENCY STOP rotary door-coupling operating mechanism (red/yellow) with				
Extension shaft			130 mm	3RV2926-0C
Extension shaft			330 mm	3RV2926-0L
Molded-plastic housing				
For motor starter protector (+ Side-mounted auxiliary block)			54 mm	3RV1923-1CA00
For motor starter protector (+ Side-mounted auxiliary block + auxiliary release)			72 mm	3RV1923-1DA00
Molded-plastic housing with EMERGENCY STOP rotary door-coupling operating mechanism				
For motor starter protector (+ Side-mounted auxiliary block)			54 mm	3RV1923-1FA00
For motor starter protector (+ Side-mounted auxiliary block + auxiliary release)			72 mm	3RV1923-1GA00

¹⁾ More versions on request

²⁾ Only available as screw-connected versions

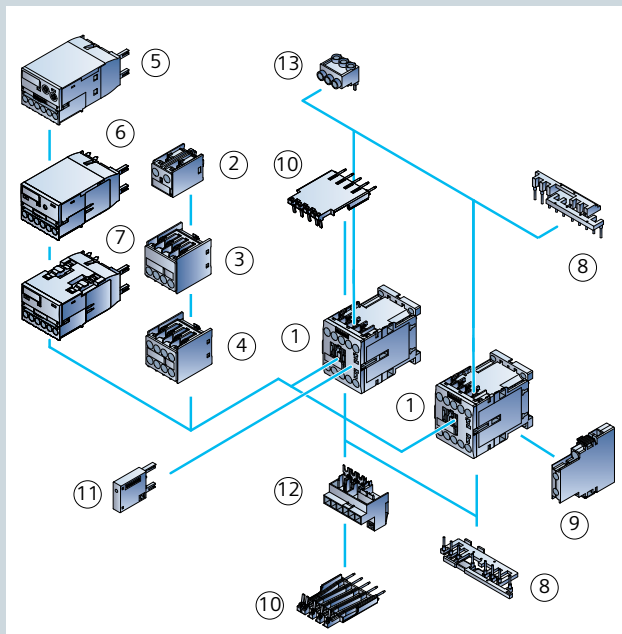

⑤ ⑥ ⑦ ⑧ see page 17 (Function modules for mounting on contactors and for interfacing the control system)

Front mounting auxiliary contacts for	Version	Order no. Screw connection	Order no. Spring-loaded connection	Order no. Ring cable lug connection	
① 3RT2 contactors	Standard	see tabular overview on page 5ff.			
	Communication	see page 16			
② 1-pole auxiliary contact block, cable entry from the top	1NO	3RH2911-1AA10	-	-	
	1NC	3RH2911-1AA01	-	-	
2-pole auxiliary contact block, cable entry from the top	1NO + 1NC	3RH2911-1LA11	-	-	
	2NO	3RH2911-1LA20	-	-	
1-pole auxiliary contact block, cable entry from the bottom	1NO	3RH2911-1BA10	-	-	
	1NC	3RH2911-1BA01	-	-	
③ 2-pole auxiliary contact block, cable entry from the bottom	1NO + 1NC	3RH2911-1MA11	-	-	
	2NO	3RH2911-1MA20	-	-	
④ 4-pole auxiliary contact blocks ¹⁾ , (in compliance with DIN EN 50 012 and DIN EN 50 005)	1NC	3RH2911-1HA01	3RH2911-2HA01	3RH2911-4HA01	
	2NC	3RH2911-1HA02	3RH2911-2HA02	3RH2911-4HA02	
	1NO + 1NC	3RH2911-1HA11	3RH2911-2HA11	3RH2911-4HA11	
	2NO + 2NC	3RH2911-1HA22	3RH2911-2HA22	3RH2911-4HA22	
	1NO	3RH2911-1HA10	3RH2911-2HA10	3RH2911-4HA10	
	2NO	3RH2911-1HA20	3RH2911-2HA20	3RH2911-4HA20	
	Auxiliary contact blocks suitable for electronic components (2-pole) (in compliance with DIN EN 50 005)	1NO + 1NC	3RH2911-1NF11	3RH2911-2NF11	-
		2NO	3RH2911-1NF20	3RH2911-2NF20	-
	2Ö	3RH2911-1NF02	3RH2911-2NF02	-	

Size-specific accessories for 3RT201 contactors (S00)					
⑨ Auxiliary contact blocks for side mounting (in compliance with DIN EN 50 012 and DIN EN 50 005)	2NO		3RH2911-1DA20	3RH2911-2DA20	-
	1NO + 1NC		3RH2911-1DA11	3RH2911-2DA11	3RH2911-4DA11
	2NC		3RH2911-1DA02	3RH2911-2DA02	-
Auxiliary contact block suited for electronic components for side mounting (on the right) (in compliance with DIN EN 50 012 and DIN EN 50 005)	1NO + 1NC	-		3RH2911-2DE11	-
Soldering pin adapter for contactors with 4-pole auxiliary contact block	For 4 contactors (pack)		3RT1916-4KA2	-	-
⑩ Soldering pin adapter for contactors	For 4 contactors (pack)		3RT1916-4KA1	-	-
⑪ Surge suppressor, e.g. varistor (AC 230 V) ²⁾	without LED	AC 127-240 V	3RT2916-1BD00	3RT2916-1BD00	3RT2916-1BD00
	with LED	AC 127-240 V	3RT2916-1JL00	3RT2916-1JL00	3RT2916-1JL00
⑫ Terminal module for contactor with screw connection	Adapter Plug	AC-3/400 V: 20 A	3RT1916-4RD01	-	-
			3RT1900-4RE01	-	-
⑬ 3-phase supply terminal	Conductor cross section: 6 mm		3RA2913-3K	-	-

¹⁾ More auxiliary contact blocks on request

²⁾ For further surge suppressors, refer to the Industry Mall or the IC 10 catalog

Accessories for 3RT202 contactors (S00)

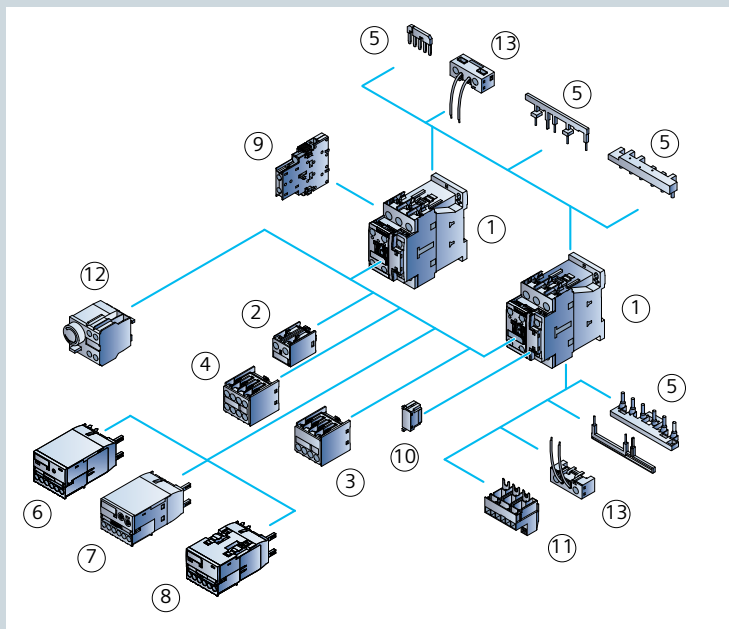

⑤ ⑥ ⑦ ⑧

Front mounting auxiliary contacts for	Comment	Version	Order no. Screw connection	Order no. Spring-loaded connection	Order no. Ring cable lug connection
① 3RT2 contactors		Standard	see tabular overview on page 5ff.		
		Communication	see page 16		
② 1-pole auxiliary contact block, cable entry from the top		1NO	3RH2911-1AA10	-	-
			3RH2911-1AA01	-	-
2-pole auxiliary contact block, cable entry from the top		1NO + 1NC	3RH2911-1LA11	-	-
		2NO	3RH2911-1LA20	-	-
1-pole auxiliary contact block, cable entry from the bottom		1NO	3RH2911-1BA10	-	-
		1NC	3RH2911-1BA01	-	-
③ 2-pole auxiliary contact block, cable entry from the bottom		1NO + 1NC	3RH2911-1MA11	-	-
		2NO	3RH2911-1MA20	-	-
④ 4-pole auxiliary contact block ¹⁾ (in compliance with DIN EN 50 012 and DIN EN 50 005)		1NC	3RH2911-1HA01	3RH2911-2HA01	3RH2911-4HA01
		2NC	3RH2911-1HA02	3RH2911-2HA02	3RH2911-4HA02
		1NO + 1NC	3RH2911-1HA11	3RH2911-2HA11	3RH2911-4HA11
		2NO + 2NC	3RH2911-1HA22	3RH2911-2HA22	3RH2911-4HA22
		1NO	3RH2911-1HA10	3RH2911-2HA10	3RH2911-4HA10
		2NO	3RH2911-1HA20	3RH2911-2HA20	3RH2911-4HA20
	Auxiliary contact blocks suitable for electronic components (2-pole) (in compliance with DIN EN 50 005)	1NO + 1NC	3RH2911-1NF11	3RH2911-2NF11	-
		2NO	3RH2911-1NF20	3RH2911-2NF20	-
	2NC	3RH2911-1NF02	3RH2911-2NF02	-	
⑧ see page 17 (Function modules for mounting on contactors and for interfacing the controller)					

Size-specific accessories for 3RT2 contactors					
⑨ Auxiliary contact blocks for side mounting (on the right)	acc. to DIN EN 50 005	2NO	3RH2921-1DA20	3RH2921-2DA20	-
	(in compliance with DIN EN 50 012 and DIN EN 50 005)	1NO + 1NC	3RH2921-1DA11	3RH2921-2DA11	3RH2921-4DA11
		2NC	3RH2921-1DA02	3RH2921-2DA02	-
Auxiliary contact block for side mounting (on the right), suitable for electronic components	acc. to DIN EN 50 005	1NO + 1NC	-	3RH2921-2DE11	-
⑩ Overvoltage limiter, e.g. varistor (AC 230 V)	without LED	AC 127–240 V	3RT2926-1BD00	3RT2926-1BD00	3RT2926-1BD00
	with LED	AC 127–240 V	3RT2926-1JL00	3RT2926-1JL00	3RT2926-1JL00
⑪ Terminal module for contactor with screw connection	Adapter	400 V/AC-3:	3RT1926-4RD01	-	-
	Plug	25 A	3RT1900-4RE01	-	-
⑫ Pneumatic delay block (in compliance with DIN EN 50 005)	0.1 – 30 s	ON delay	3RT2926-2PA01	-	-
	1 – 60 s		3RT2926-2PA11	-	-
	0.1 – 30 s	OFF delay	3RT2926-2PR01	-	-
	1 – 60 s		3RT2926-2PR11	-	-
⑬ Coil terminal module	Connection from the top		3RT2926-4RA11	3RT2926-4RA12	-
	Connection from the bottom		3RT2926-4RB11	3RT2926-4RB12	-
	Diagonal connection		3RT2926-4RC11	3RT2926-4RC12	-

¹⁾ More auxiliary contact blocks on request

²⁾ For further surge suppressors, refer to the Industry Mall or the IC 10 catalog

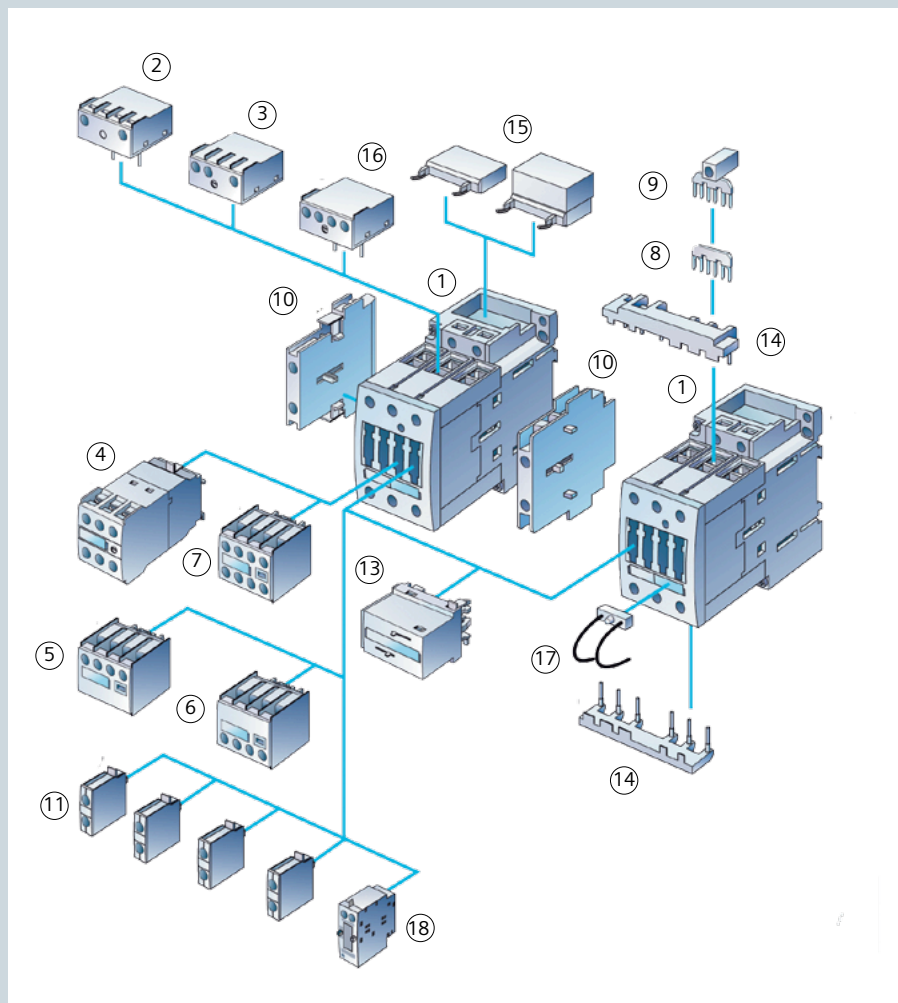

	Version	For size	Order no.
① Contactor, size S2 (example) control supply voltage	7.5 kW/400 V 230 V 50 Hz		3RT10 25-1AP00
For sizes S2 to S3			
② Solid-state time-delay block, ON delay	0.5 – 10 s		3RT19 26-2CH21
③ Solid-state time-delay block, OFF delay	0.5 – 10 s		3RT19 26-2DH21
④ Auxiliary switch block, solid-state time-delay	ON delay	0.5 – 10 s	3RT19 26-2ED21
	OFF delay	0.5 – 10 s	3RT19 26-2FL21
⑤ 2-pole auxiliary switch block, cable entry from above	1NO + 1NC		3RH19 21-1LA11
⑥ 2-pole auxiliary switch block, cable entry from below	1NO + 1NC		3RH19 21-1MA11
⑦ 4-pole auxiliary switch block, (terminal designations acc. to DIN EN 50 012 or DIN EN 50 005)	2NO + 2NC	–	3RH19 21-1HA11
⑧ Link for paralleling (star jumper), 3-pole, without terminal		S2	3RT19 36-4BA31
		S3	3RT19 46-4BA31
⑨ Link for paralleling, 3-pole, with terminal		S2	3RT19 36-4BB31
		S3	3RT19 46-4BB31
⑩ 2-pole auxiliary switch block, can be laterally mounted (left or right), (terminal designations acc. to DIN EN 50 012 or DIN EN 50 005)	1NO + 1NC	S2 – S12	3RH19 21-1DA11
⑪ 1-pole auxiliary switch block (up to 4 can be snapped on)	1NO	S2 – S3	3RH19 21-1CA10
	1NC	S2 – S3	3RH19 21-1CA01
⑫ Mechanical interlock, can be laterally mounted	–	S2 – S3	3RA19 24-2B
⑬ Mechanical interlock, can be mounted at the front	–	S2 – S3	3RA19 24-1A
⑭ Wiring connectors at the top and bottom (reversing operation)		S2	3RA19 23-2A
		S2	3RA19 33-2A
		S3	3RA19 43-2A
⑮ Surge suppressor (varistor, RC coupling, diode combination), can be mounted at the top or bottom	–	S2 – S3	3RT19 26-1BD00
⑯ Interface for mounting directly onto the contactor coil	–	S2 – S3	3RT19 26-3AB31
⑰ LED module to indicate contactor operation	–	S2 – S3	3RT19 26-1QT00
⑱ Mechanical latching	AC/DC 24	S2	3RT19 26-3AB31
	AC/DC 110	S2	3RT19 26-3AF31
	AC/DC 230	S2	3RT19 26-3AP31

¹⁾ For further surge suppressors, refer to the Industry Mall or the IC 10 catalog

Accessories for 3RT1 contactors (S6 to S12)

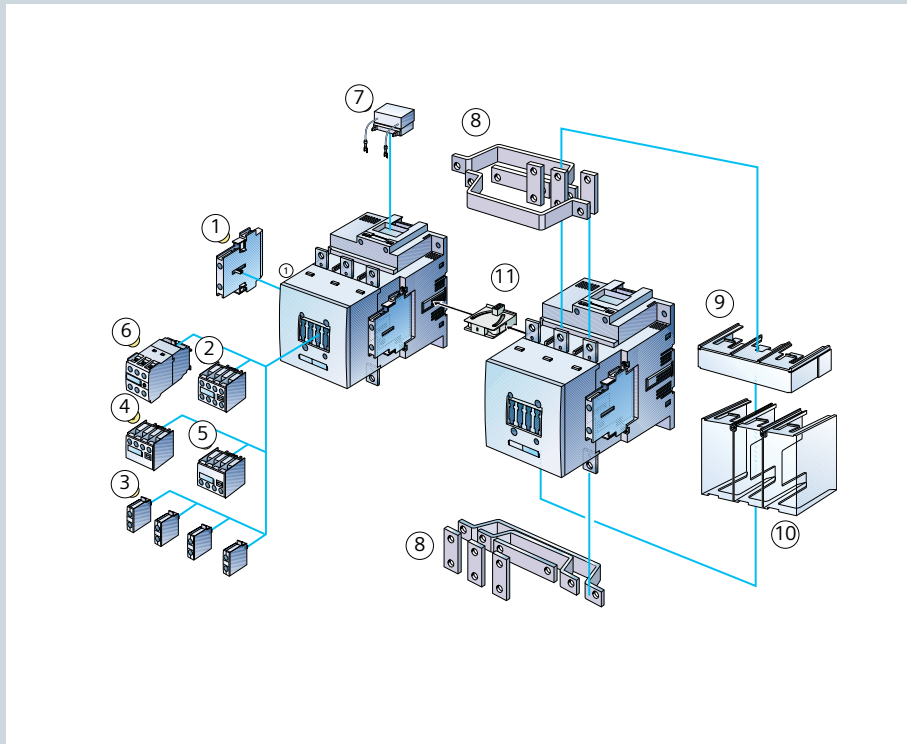

Type	Version	Order no.
① 2-pole auxiliary switch block, can be laterally mounted	- 2nd block (left/right), DIN EN 50 012	1NO + 1NC 3RH1921-1JA11
	- 2nd block (left/right), DIN EN 50 005	1NO + 1NC 3RH1921-1KA11
		2NO 3RH1921-1KA20
② 4-pole auxiliary switch block, can be mounted at the front	- with classification No. 5...8, DIN EN 50 012	2NO + 2NC 3RH1921-1XA22-0MA0
	- with classification No. 1...4, DIN EN 50 012	2NO + 2NC 3RH1921-1HA22
③ 1-pole auxiliary switch block, can be mounted at the front	1NO	3RH1921-1CA10
	1NC	3RH1921-1CA01
④ 2-pole auxiliary switch block, can be mounted at the front, cable entry from above, DIN EN 50 005	1NO + 1NC	3RH1921-1LA11
⑤ 2-pole auxiliary switch block, can be mounted at the front, cable entry from below, DIN EN 50 005	1NO + 1NC	3RH1921-1MA11
⑥ Auxiliary switch block, solid-state time-delay	1NO + 1NC	
	- ON delay, AC 200–240 V	0 ... 10 s 3RH1926-2ED21
	- OFF delay, AC 200–240 V	0.5 ... 10 s 3RH1926-2FL21
⑦ RC element, AC 127–240 V ¹⁾		3RT1956-1CD00
⑧ Wiring connectors top and bottom	for S6	3RA1953-2M
	for S10	3RA1963-2A
	for S12	3RA1973-2A
⑨ Connection cover for box terminals	for S6	3RT1956-4EA2
	for S10/S12	3RT1966-4EA2
⑩ Terminal cover for cable lug and busbar connection	for S6	3RT1956-4EA2
	for S10/S12	3RT1966-4EA2
		3RT1966-4EA2
⑪ Mechanical interlock		3RA1954-2A

Operating mechanism types

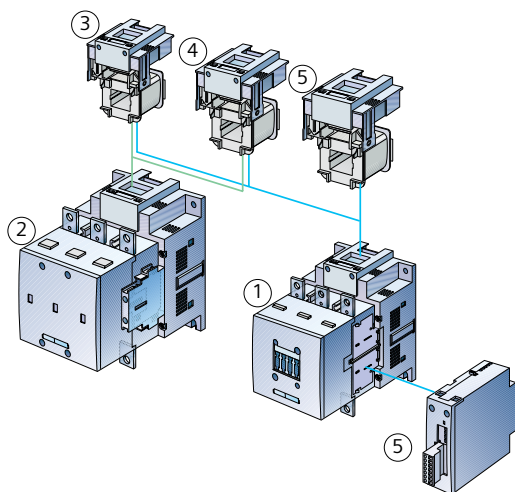



- ① 3RT10 and 3RT14 air contactors, Sizes S6, S10 and S12
- ② 3RT12 vacuum contactor, Sizes S10 and S12
- ③ Withdrawable coils for contactors with conventional operating mechanism 3RT1...-A..
- ④ Withdrawable coils for contactors with electronic operating mechanism 3RT1...-N..
- ⑤ Withdrawable coils and laterally mounted module (can be plugged in) for contactors with electronic operating mechanism and remaining lifetime signal 3RT1...-P.. and 2RT1...-Q

Size	3-phase-motor 400 V/AC-3	Contactor without coil	Withdrawable coil for operating mechanism	
			conventional control supply voltage AC/DC 220...240 V	electronic AC/DC 200...277 V
	kW	Order no.	Order no.	Order no.
S6	55	3RT1054-1LA06	3RT1955-5AP31	3RT1955-5NP31
	75	3RT1055-6LA06		
	90	3RT1056-6LA06		
S10	110	3RT1064-6LA06	3RT1965-5AP31	3RT1965-5NP31
	132	3RT1065-6LA06		
	160	3RT1066-6LA06		
S12	200	3RT1075-6LA06	3RT1975-5AP31	3RT1975-5NP31
	250	3RT1076-6LA06		

¹⁾ For further surge suppressors, refer to the Industry Mall or the IC 10 catalog



Version	For size	Order no.	Can be combined with the following overload and current monitoring relays			
			3RU2	3RB3	3RR21	3RR22
Relay base for stand-alone mounting						
For mounting the overload relays separately	S00	3RU2916-3A□01	●	●	●	●
For screw and snap-on mounting on TH 35 DIN rail	S0	3RU2926-3A□01	●	●	●	●
Mechanical RESET consisting of:						
Reset slide, holder and funnel	S00, S0	3RU2900-1A	●			
Reset slide, holder and funnel	S00, S0	3RB3980-0A		●		
Push button with elongated stroke (12 mm), IP65, Ø 22 mm	S00, S0	3SB3000-0EA11	●	●		
Extension tappet to even out the spacing between a push button and the reset button of the relay	S00, S0	3SX1335	●	●		
Cable release with holder for RESET for bores Ø 6.5 mm in the control panel						
Length 400 mm	S00, S0	3RU2900-1B	●			
Length 400 mm	S00, S0	3RB3980-0B		●		
Length 600 mm	S00, S0	3RU2900-1C	●			
Length 600 mm	S00, S0	3RB3980-0C		●		
Sealable cover for 3RB20/21, transparent						
For covering the setting components	S00, S0	3RV2908-0P	●			
For covering the setting components	S00, S0	3RB3984-0		●		
For covering the setting components	S00, S0	3RR2940			●	●
Modules for remote reset						
AC/DC 24 ... 30 V	S00, S0	3RU1900-2AB71	●			
AC/DC 110 ... 127 V	S00, S0	3RU1900-2AF71	●			
AC/DC 220 ... 250 V	S00, S0	3RU1900-2AM71	●			

Screw connection: 
 Spring-loaded connection: 

Accessories for 3RU11 thermal overload relay and 3RB20/21 solid-state overload relay



Version	For size	Order no.	
Terminal support for stand-alone assembly for 3RU11			
for separately mounting the overload relays, screw-type and snap-on fastening on TH 35 DIN rails, size S3 also for TH 75 DIN rails	S2	3RU1936-3AA01	
	S3	3RU1946-3AA01	
Mechanical RESET for 3RU11 and 3RB20/21 comprising:			
① Resetting plunger, holder and former	S2 – S10/S12	3RU1900-1A	
② Push button with extended stroke (12 mm), IP65, Ø 22 mm	S2 – S10/S12	3SB3000-0EA11	
Extension plunger for compensation of the distance between a push button and the relay's release button	S2 – S10/S12	3SX1335	
Cable release with holder for RESET 3RU11 and 3RB20/21 for holes 6.5 mm diameter in the panel; max. panel thickness 8 mm			
Length 400 mm	S2 – S10/S12	3RU1900-1B	
Length 600 mm	S2 – S10/S12	3RU1900-1C	
Sealable cover, transparent for 3RB20/21			
to cover the setting elements	S2 – S10/S12	3RB2984-0	
Terminal covers for 3RU11 and 3RB20/21			
Cover for cable lug and busbar connection	S3	3RT1946-4EA1	
	S6	3RT1956-4EA1	
	S10/S12	3RT1966-4EA1	
Cover for box terminals	S2	3RT1936-4EA2	
	S3	3RT1946-4EA2	
	S6	3RT1956-4EA2	
	S10/S12	3RT1966-4EA2	
Cover for the screw connection between the contactor and overload relay without box terminals (1x is required for each combination)	S6	3RT1956-4EA3	
	S10/S12	3RT1966-4EA3	
Box terminal block			
for round and ribbon cables	up to 70 mm ²	S6	3T1955-4G
	up to 120 mm ²	S6	3T1956-4G
	up to 240 mm ²	S10/S12	3T1966-4G

Accessories for motor starters

3-phase motor 400 V/AC-3 [kW]	Enclosure for direct starters	Size	Order no.
22	Moulded-plastic enclosure for wall mounting IP65 degree of protection with actuator elements	S2	3RE1933-1CB3

Components required		
	Order no.	Qty.
Contacteur	3RT10 3	1
Thermal or solid-state overload relay	3RU11 36 resp. 2RB10 36	1
Lateral auxiliary switch 1NO/1NC	3RH1021-1DA11	1

Support

As competent and reliable partner, we not only offer tried-and-tested products and systems, but also comprehensive support – from initial information to planning, configuration and ordering, down to commissioning, ongoing operation and technical service:

- Access to all important and up-to-date information: From the website to the newsletter, down to the download of complete brochures
- Ordering and information platform for all products and systems
- Efficient tools for increased productivity, e.g. CAx Data for your configuration process
- Service & Support Portal for comprehensive technical information on configuration and system documentation

We thus provide you with a comfortable basis for optimizing your processes. In short: **Support for improved efficiency!**

	Information	Planning	Configuration	Ordering	Commissioning	Operation	Service
Promotion website	Product information						
Newsletter portal	Product information						
Information and Download Center	Product information						
Industry Mall		Product selection					
Software for Industrial Controls		Product & system engineering					
Service & Support Portal			Product documentation				
CAx-Data			Product documentation				
Image database			Product documentation				
SITRAIN Portal						Product training	
Technical Assistance							Product hotline

Product information



Comprehensive information on Industrial Controls

Amongst others, rapid and targeted provision of information on:

- SIRIUS Industrial Controls

Ensure your success with our trendsetting system solutions!

www.siemens.com/sirius



Newsletter: always up to date

Constantly updated information on the subjects of Industrial Controls

www.siemens.com/industrial-controls/newsletter

Product information



Easy download of catalogs and information material

Our Information and Download Center offers all current

- Catalogs
- Customer magazines
- Brochures

for download

www.siemens.com/industrial-controls/infomaterial

Product selection

Product selection



Industry Mall: platform for e-business and product information

Benefit from 24/7 access to our comprehensive information and ordering platform for the complete Industrial Controls portfolio, including:

- Selection tools, product and system configurators
- Availability check
- Order tracking

www.siemens.com/industrial-controls/mall

www.siemens.com/industrial-controls/configurators

Product & system engineering

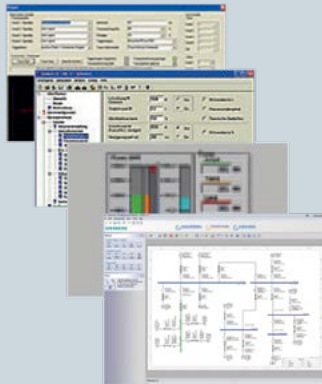

Software for Industrial Controls: easy, fast and safe

Our software supports you throughout all project phases – from planning to parametrization, down to operation.

- Parametrization and Configuration with SIRIUS Industrial Controls
- Planning and Dimensioning of electrical power distribution systems with SIMARIS

www.siemens.com/industrial-controls/mall

www.siemens.com/simaris

Product documentation



Online support: full-range technical product information

24/7 access to comprehensive technical information on our products and systems to support you from the planning to the configuration down to the operation phase.

- Product data sheets, manuals/operating instructions
- Certificates, characteristic curves, downloads
- FAQs

www.siemens.com/industrial-controls/support



Technical Product Data for CAx Applications: immediate availability of configuration-relevant CAx data types for your CAD/CAE system
This DVD provides you with a comprehensive pool of configuration-relevant CAx data types.

- Commercial and technical product master data
- 2-D dimension drawings, isometric illustrations and 3-D models
- Product data sheets
- Tender specifications

CAx Online-Generator:

www.siemens.com/industrial-controls/support

CAx-DVD:
Order no. E86060-D1000-A207-A7-6300 (Industry Mall)

Product training



Easy download of product image material

Our image database contains all current

- Product images
- 2-D dimension drawings, isometric illustrations and 3-D models
- Internal circuit diagrams
- Symbols

in diverse versions for free download.

www.siemens.com/industrial-controls/picdb



Training: knowledge expansion

Our training offer both comprises an overview as well as detailed competencies regarding selected products and systems. Amongst others, you can expand your product and system know-how of SIRIUS.

www.siemens.com/sitrain

Or contact us personally via the information hotline:

via telephone:
+49 (911) 895 7575

via fax:
+49 (911) 895 7576

via e-mail:
info@sitrain.com

Product hotline



Technical Assistance: competent Industrial Controls expert consulting

We support you with all technical enquiries regarding our products and systems – both before and after delivery.

- Product selection
- Old/new conversions, competitor conversions
- Special versions, special requirements
- Commissioning, operation

Tip: the Service & Support Portal, including the FAQ database, can be called up via www.siemens.com/industrial-controls/technical-assistance. You can also directly submit your support request to a technical consultant.

www.siemens.com/industrial-controls/technical-assistance

Personally from Mo. through Fr. 8.00 am to 5.00 pm (CET)

via telephone:
+49 911 895 5900

via e-mail:
technical-assistance@siemens.com

via fax:
+49 911 895 5907

Siemens AG
Industry Sector
Control Components and
Systems Engineering
P.O. Box 23 55
90713 FÜRTH
GERMANY

Subject to changes 08/13
Order No.: E20001-A380-P302-V8-7600
Dispo 27601
WÜ MP.R3.CL.0000.00.3.28 WS 08133.0
Printed in Germany
© Siemens AG 2012

The information provided in this brochure contains merely general descriptions or characteristics of performance which in case of actual use do not always apply as described or which may change as a result of further development of the products. An obligation to provide the respective characteristics shall only exist if expressly agreed in the terms of contract.

All product designations may be trademarks or product names of Siemens AG or supplier companies whose use by third parties for their own purposes could violate the rights of the owners.